

Fentec

Terranota Ltd. P.O. Box 1703 Invercargill 1703
 Telephone: 0800 002 725
 Email: sales@fentec.co.nz
 Website: www.fentec.co.nz

Model
VistaWall Horizontal Solid Panel 1200mm
FVHOF1218

For use on Swimming Pools, External Balconies or Retaining Walls, please refer to our Producer Statments for further specifications.

UNLESS OTHERWISE SPECIFIED, DIMENSIONS ARE IN MILLIMETERS

Channel profile	30x30x1460mm channel	Channel fixing	Aluminium end channel fixed with tek screws hidden under channel cover
Paling profile	145x16x1780mm paling	Post caps	Internal plastic caps for end channel 65x65mm posts have either internal or external cap option
Panel length	1800x1170mm	Flanged post	65x65x1600mm (125mm square flange) M12 fixings
		Inground post	65x65x2200mm

Size A4	Date issued 2023-03-31	Rev	DO NOT SCALE DRAWING
-------------------	----------------------------------	-----	----------------------

Sheet 1 of 1	Weight
------------------------	--------

VISTAWALL INSTALLATION GUIDE - SOLID

A STEP-BY-STEP GUIDE TO INSTALLING YOUR FENCE

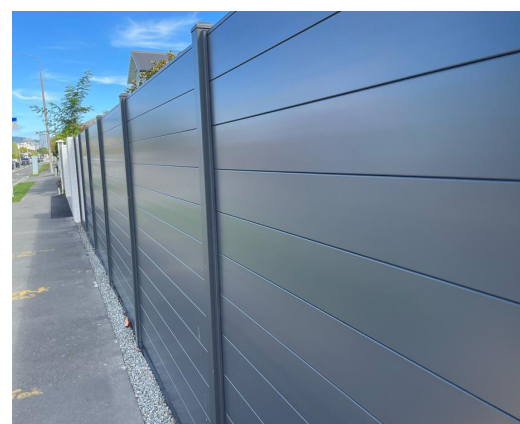
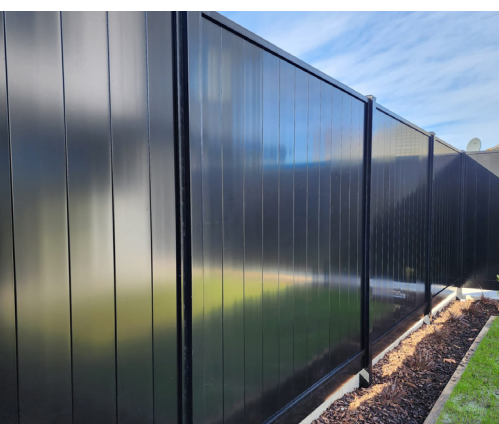



INTRODUCTION

Thank you for choosing Fentec Aluminium range. This product will provide you with many years of trouble free protection if installed in accordance with the directions outlined in this document.

The recommendations detailed in this guide are formulated along the lines of good building practice. They are not intended to be an exhaustive statement of all the relevant data.

If you have any questions, please contact our Technical Team on 0800 002 725. We are always happy to help in any way we can.

BEFORE YOU START, READ THIS

- ✓ This guide does not apply to any fences over 1.8m in height. If your fence is greater than 1.8m, please seek further advice from Fentec.
- ✓ Describe your site details when ordering materials.
- ✓ Identify your soil type/ground conditions. Refer to the table in Step 2. This will determine the concrete and footing details required.
- ✓ Make sure you are aware of underground services before you start digging! These could be gas, electricity, or water mains. Call your local council for more information.
- ✓ Check your local council regulations on boundary fencing.
- ✓ Check the delivered material for the correct number of components and general condition before beginning your installation.

TOOLS LIST

- Make sure you choose the right tools before start installing your fence.



It is recommended that the reader pays particular attention to those items identified as IMPORTANT in this manual to ensure satisfactory long-term performance.

TOOLS

- Tape Measure
- Spade
- Shovel
- Level
- String Line
- Concrete

OPTIONAL

- Powered Auger - 300mm diameter
- Hacksaw or powered metal cutting saw
- Laser-level

SAFETY GEAR

minimum required

- Safety Boots
- Gloves
- Helmet
- Eye Protection
- Hearing Protection
- Sun Protection



COMPONENTS LIST

Required for this product

These items below are not included but one type of post and cap are required for installation.



145 x 16 x 1780mm TGV Paling

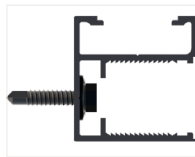

30 X 30 Paling channel



Tek screws

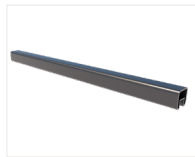

Channel cover



Channel cover clip



Channel ends caps, left & right



65 X 65 in-ground post

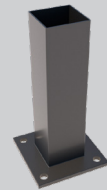

65 X 65 flanged post

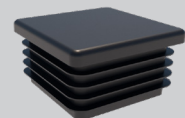

Plastic knock in cap

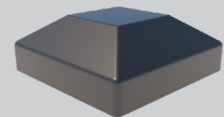

Aluminium post cap

Conversion kit components

To change the orientation of your fence



100 X 16 x 1780mm Slat

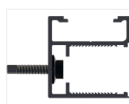

30 X 30 slat channel



Tek screws

A STEP-BY-STEP GUIDE TO INSTALLATION

STEP 1 - LAYOUT YOUR FENCE-LINE

- ✓ Determine and mark any legal boundaries and/or underground services.
- ✓ Measure out each fence-line and mark the post positions.
- ✓ Determine post centres as follows:
- ✓ If the fenceline length does not work out as multiples of the standard panel length - adjust the length of the last section, or the last few sections, to suit and cut panels to fit.
- ✓ Use a string line or laser-level to make sure any straight lines are aligned.

$$\begin{array}{r} \text{Panel Length} \\ \hline \end{array} + \begin{array}{r} \text{Post Size} \\ \hline \end{array} = \begin{array}{r} \text{POST} \\ \text{CENTRE} \\ \hline \end{array}$$

e.g. 1800mm + 65mm = 1865mm

STEP 2 - DIG POST HOLES

Dig post holes using hand tools and/or a powered auger. See Tables A & B for required post-hole dimensions and depths

Required post-hole depth into firm earth or clay

Wall Height	Post hole depth
900mm	450mm
1200mm	550mm
1500mm	600mm
1800mm	600mm

Notes:

For higher walls, you will need engineering advice beyond the scope of this publication
The diameter of your holes should be large enough to have a minimum of 75mm clearance around the post
Please note that 1800mm is the standard height. Heights lower than 1800mm can be done using these components, with wastage.

Recommended footing depths listed in this table are for wind regions A & B, plus terrain categories 2.0, 2.5 & 3. If you are building your fence in a cyclonic wind area, on top of a hill, adjacent to an escarpment, on a ridge or in terrain category 1, you will need engineering advice beyond the scope of this publication

MARKING OUT YOUR POST HOLES

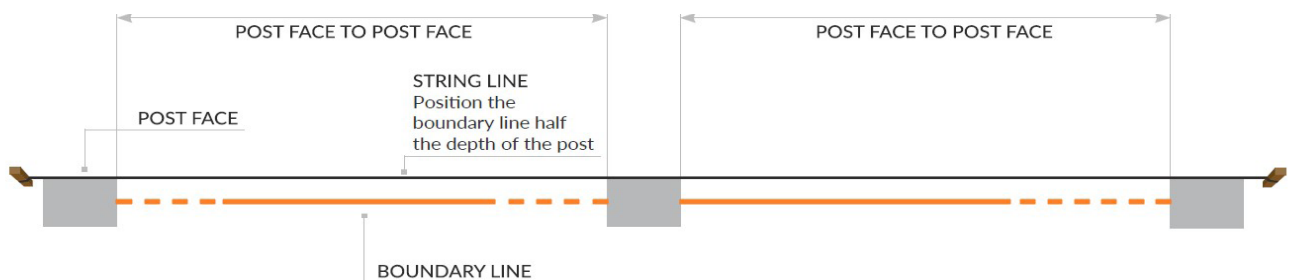

Standard 'post centre to post centre' guide

The table above allows you to work out what your post centres will be. If you have 1780mm paling [allowing for 10mm either side of the channel] and you are using 65x65mm posts, then you will have an 1865mm post centre to post centre. This also shows the in-between measurements, should you be fitting your paling between posts other than a 65x65mm profile, i.e. timber posts or concrete blocks

STEP 3 - INSTALLING THE POSTS IN GROUND

3.1 Place the post into the hole and set the height carefully using a tape measure, or preferably a laser level.

CAUTION: Ensure you allow enough height on the post to allow for: panel height + ground clearance (suggest 50-100mm) + additional 10mm for external cap clearance.

3.2 Fill the hole with concrete around the post taking care to keep the post in the correct position.

3.3 Check with a spirit-level regularly to ensure the post is plumb.

3.4 Ensure the post remains square to the fenceline and does not turn as you lace concrete around it.

3.5 Repeat Steps 3.1 to 3.4 for all posts.

3.6 Set the spacing of the posts at the length of the panel, plus approx 5mm clearance (as per STEP 1).

TIP: cut a spacer-stick out of timber at the correct length between posts.

IN-GROUND POST:

FAP6519	65x65x1900mm
FAP6522	65x65x2200mm
FAP6525	65x65x2500mm
FAP1025	100x100x2500mm

(Post sizes are dependent on the application and design requirements)

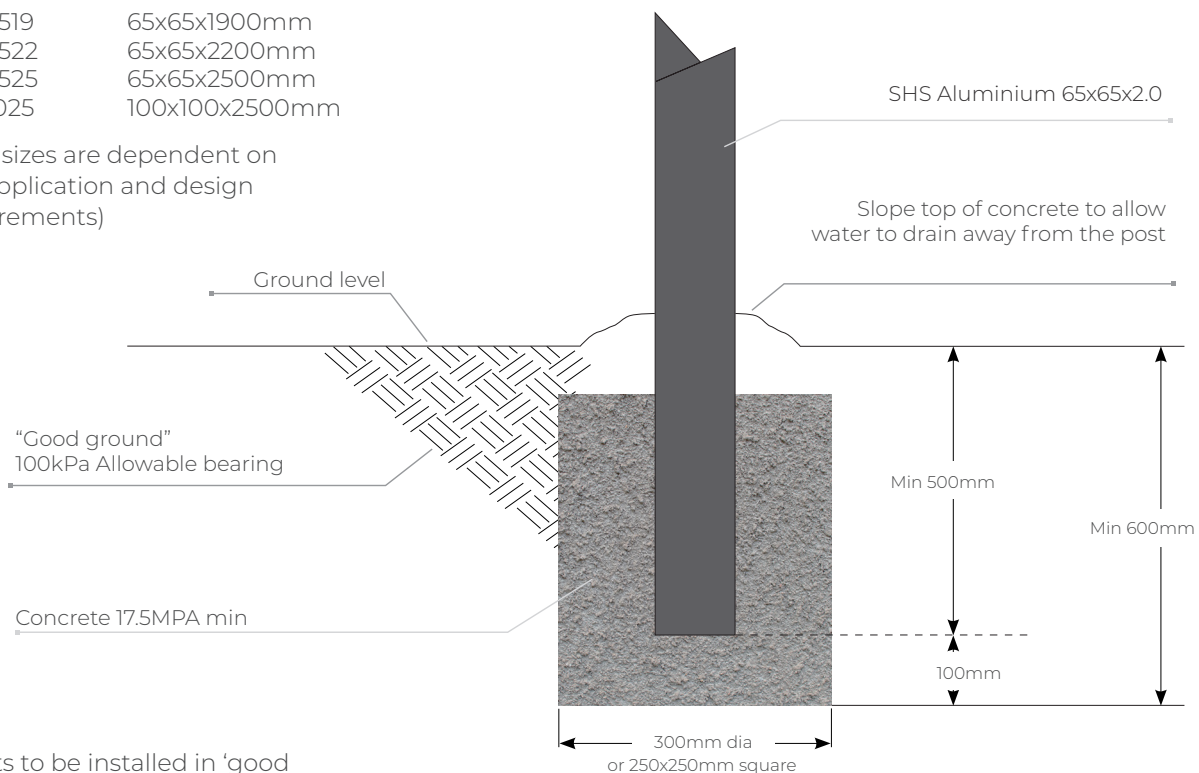

*Posts to be installed in 'good ground' as defined by NZS3604

NOTES:

- ✓ For standard 65x65 aluminium posts, a fairly dry concrete mix can be used which will hold the post in place without any bracing while the concrete dries. However, the site must be re-visited before concrete sets firm to recheck post alignment and correct if required.
- ✓ Any heavier posts (e.g. gate posts) should be concreted in place and braced until the concrete is dry.
- ✓ If the fence line follows any contours in the land or the fence line is curved, regularly check the height of the posts as you work down the line to ensure a good visual line along the top of the fence.

STEP 4 - INSTALLING POSTS, BOLT-DOWN OPTION

4.1 Ensure the surface you are bolting the post to is firm, level, and clean. (See Figure below)

BOLT-DOWN POST:

FAF6513 65x65x1300mm
FAF6519 65x65x1900mm

(Post sizes are dependent on the application and design requirements)

Fixings: (indicative)

In concrete: 4 x M12 HILTI HST stud anchors or similar with min 70mm embedment.

In timber: 4 x 12mm coachscrews with min 120mm embedment.

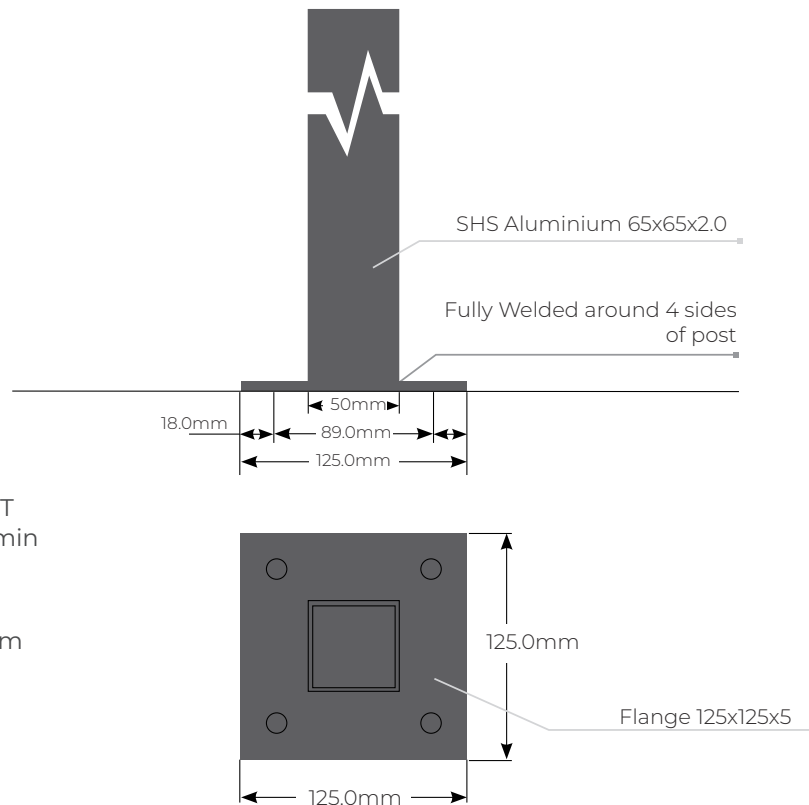

4.2 Fix the posts in place with four fixings of the correct type for the situation.

STEP 5 - PALING CHANNEL INSTALLATION

5.1 If your channels are not the desired length then these will need to be cut, ideally, with a dropsaw to obtain a clean cut without heating the aluminium to a point that it burns the powdercoating.

With the use of a tape measure, string line/chalk line, or if you have access to a laser level, you can mark the heights of the top of your paling channel on your posts.

Note: if your site has sloping ground it may be required to step your fence from bay to bay. Once a height has been established for all of your channels, with the tek screws supplied, screw your channel directly to your post whilst keeping the top of your channel at the marks you have made on your post

Your screws should be approximately 300-400mm apart down the length of your channel.

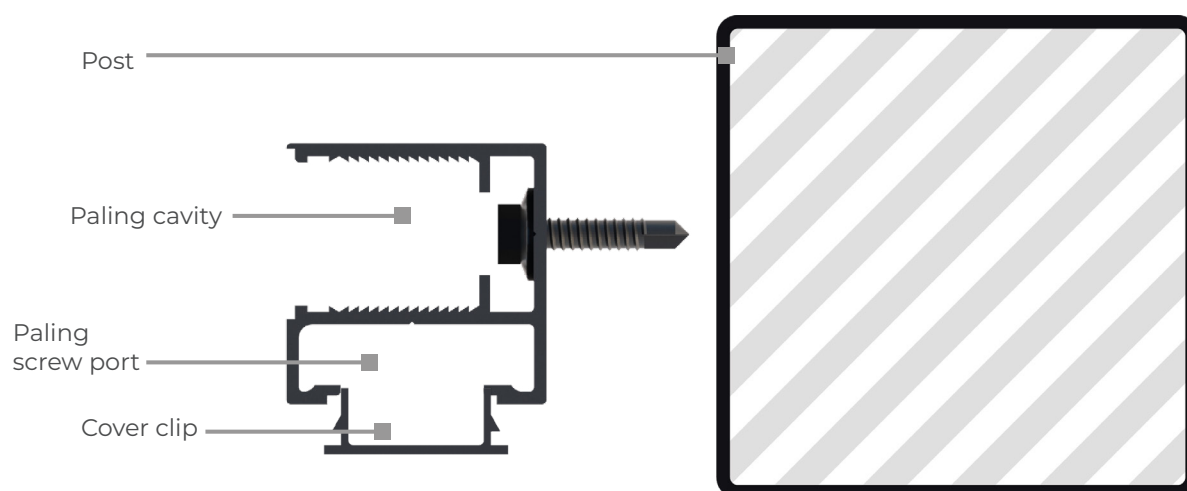

Note:

Make sure the post is elevated 10mm higher than the channel to allow for a post cap the paling channel is asymmetrical.

To ensure your fence aesthetically looks correct, make sure the 'screw port side' is all facing the same direction (generally on the inside of your property looks best).

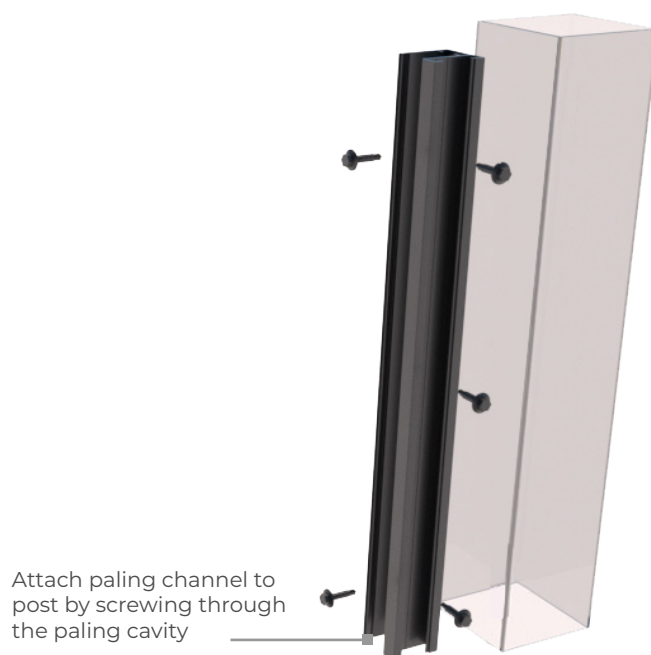

STEP 5 - PALING CHANNEL INSTALLATION CONT.

5.2 Fitting palings

See vertical conversion guide on pg 9 to change the orientation of your fence.

The palings have a groove one side and a tongue on the other, so they interlock when stacked on each other.

Starting at the bottom, slide and screw the first paling into the channel with the tongue up, then slide the next paling in with its groove locking over the tongue and repeat until they are all stacked. Then place the tongue cover over the last paling and screw into place.

If you do a lower height than 1800mm, you will need to divide the height of your wall into the number of palings you have to obtain the closest number of palings.

Note: It is important to maintain both parallel and level within each bay. This will ensure a straight looking fence. This can be achieved by using a tape measure to check for the 'parallel' with either the top of the channel or your starting point.



STEP 6 - COVER CLIP INSTALLATION

6.1 Insert channel cover clip and channel caps

Once all your palings have been assembled you can now install the cover clip to the channel to hide all visible fixings.

Make sure the cover clip is the same length as your paling channel, then you are ready to insert.

The easiest way to do this is to use either a rubber mallet or the rubber handle of a hammer. Do not use the metal part of your hammer as this may damage the powder coating.

Insert one edge of the cover clip into the channel, then firmly tap in the other edge along the length of the channel until it is all secured in place.

Once all the palings have been installed, we have an optional cap to cover the profile of the paling channel. These consist of a left and right hand cap.

Caps are just inserted onto the top of the channel.

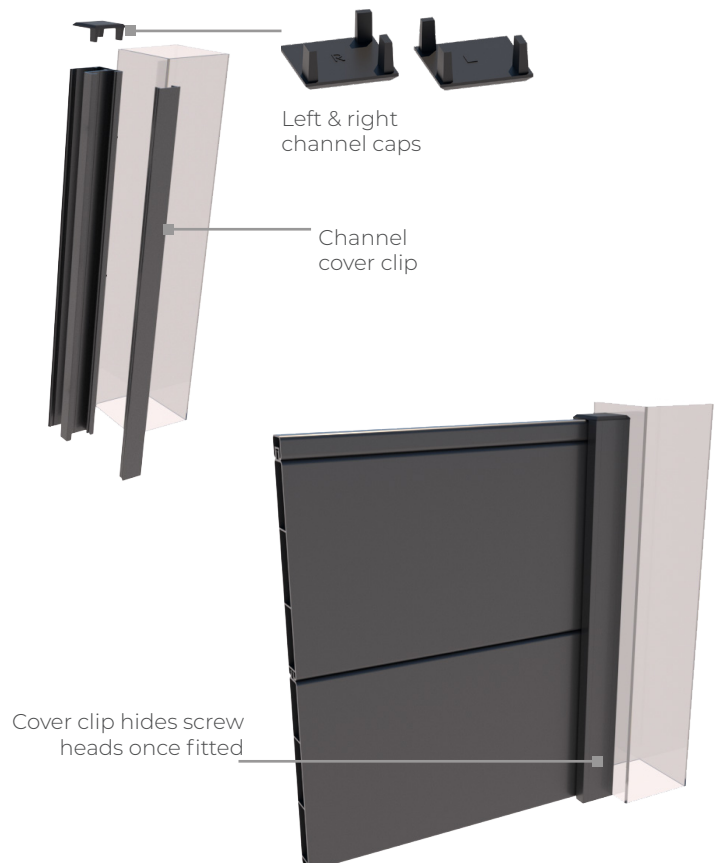

VERTICAL CONVERSION GUIDE

How to Convert the orientation of your VistaWall Solid fence

Important:

Please read thoroughly before commencing with installation

Cutting of components prior to install - this will need to be done on-site with a drop saw

The maximum panel height is 1755mm.

All vertical palings will need to be cut to achieve your desired fence height.

This is based on your vertical channel minus bottom horizontal slat of 100mm minus top/bottom channel (allow 20mm).

Note: This is critical to avoid any excess cutting

See table below as an example for 1755mm high panel

Panel Height	=	Bottom Slat	+	Top/Bottom channels	+	Paling Length
e.g. 1755mm	=	100mm	+	allow 20mm	+	1630mm

The bottom slat length is determined by post-to-post measurement minus 20mm for vertical channels.

e.g., final measurement of bottom slat will be 1740mm for a 1760mm panel width.

Trim bottom channel to the total length of the exposed slat between posts

Installation

Fitting bottom paling

Depending on the total width of the bay, the maximum post width face to face is 1760mm.

Lay the additional slat horizontal and screw fix on either end. Trim channel to the total length of the exposed paling between posts. Screw fix this to the top of the slat, this will become the base of the vertical palings.

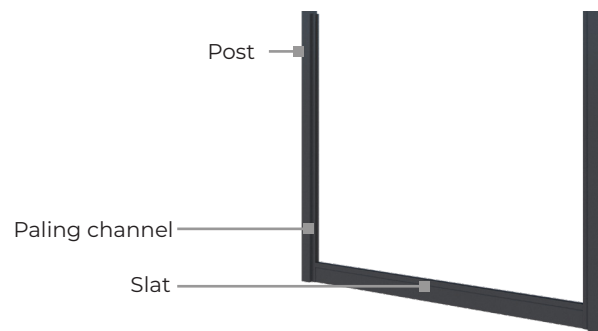

Fitting vertical palings

Starting from one side, fix one paling against one side and work across, making sure the tongue and grooves are fully secured.

Tip: use a strap or similar close to the top of the post to secure the inserted palings while installing.

Palings will need to be cut to fit the height on the channel



Fitting top cap

After fitting all the palings, place the top cap across and screw fit to secure the fence



FREQUENTLY ASKED QUESTIONS

What is the best method to cut aluminium?

For the best results, use a drop saw with an aluminium cutting blade. This will create a clean, square cut. A grinder is acceptable, provided you use a thin metal cutting blade to reduce the risk of burning the powdercoat.

Can this be installed in coastal areas?

Yes, we have a 5 year warranty on our products. If you are in a coastal zone then an increase of cleaning and maintenance will be required.

We do not recommend the product to be in direct contact with salt water.

What do I do if I have hard water?

Regular cleaning of your fence will be required to help prevent water spots from appearing. Hard water is corrosive to the powder coating, therefore neglect will cause deterioration to your fence.

Can this be used for a balustrade?

No, currently, this has not been tested for balustrade purposes.

How do I set up my posts around angles?

You will need two posts for this. The channel system is required to be square to the posts and palings. This can only be done with two posts side by side.

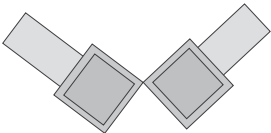

CONTACT FENTEC

FENTEC'S TECHNICAL SUPPORT: 0800 002 725

TO LEARN MORE VISIT: WWW.FENTEC.CO.NZ

This document is only intended to be a general guide, as every property and situation is different. Any installation work, including the use of power equipment is completely the responsibility of the person(s) installing. All persons using power equipment must be trained and certified to use the equipment and must wear all applicable personal protection gear. Fentec cannot accept any responsibility for any faulty installation or damage or injury arising from installation work.



0800 002 725 | fentec.co.nz