

the AirRounder™ Connect

Instruction Book - LPH408



Breville®



Contents

- 2 Breville Recommends Safety First
- 8 Components
- 8 Remote Control Panel
- 9 Control Panel
- 9 Display Screen
- 10 Features
- 11 Assembly
- 12 Functions
- 17 Wi-Fi Connectivity
- 18 Care, Cleaning & Storage
- 19 Replacing the Filter
- 21 Troubleshooting

BREVILLE RECOMMENDS SAFETY FIRST

At Breville we are very safety conscious. We design and manufacture consumer products with the safety of you, our valued customer, foremost in mind. In addition, we ask that you exercise a degree of care and adhere to the following precautions.

SPECIFICATIONS

Filter Life	Approx. 6 months
Product Dimensions (HxWxL mm)	450 x 245 x 260
For room size	15 to 25 m ²
Noise level (Max)	60dBA
Power Consumption	1800W
Weight	Approx. 4.4kg
OS Compatibility	Android® 5.0 or later and iOS 9.0 or later



NOTE

Not compatible with the Google Home, Amazon Alexa or other similar voice-assisted appliances.

IMPORTANT SAFEGUARDS

READ ALL INSTRUCTIONS BEFORE USE AND SAVE FOR FUTURE REFERENCE

- Carefully read all instructions before operating the purifier fan heater for the first time and save for future reference.
- Always ensure the purifier fan heater is properly assembled before use. Follow the instructions provide in this instruction book.
- Remove and safely discard any packaging material and promotional labels before using the purifier fan heater for the first time.

- To eliminate a choking hazard for young children, remove and safely discard the protective cover fitted to the power plug of this purifier fan heater.
- Avoid touching the purifier fan heater body while it is on as some parts of the purifier fan heater are hot. When moving the purifier fan heater, switch OFF and let the purifier fan heater cool down before attempting to move it.
- When moving the purifier fan heater, always carry the purifier fan heater by the base. Do not attempt to move the purifier fan heater by the power cord.
- Keep combustible materials such as drapes and other furnishings at least 1.7 meters from the front, sides and rear of the purifier fan heater.
- Extreme caution and supervision are necessary when this purifier fan heater is used by or near children, invalids or animals.
- Children should be supervised to ensure that they do not play with the purifier fan heater.
- Do not use this purifier fan heater in the immediate surroundings of a bath, a shower or a swimming pool. Do not immerse or allow liquids to be spilt on the purifier fan heater.
- Do not use the purifier fan heater to dry your laundry.
- This purifier fan heater has hot and arcing or sparking parts inside. Do not use in areas where petrol, paints, aerosols or other flammable substances are used or stored.
- Do not allow materials that have been in contact with oil, petroleum-based products or drying fluids to come in contact with the purifier fan heater.
- Do not operate the purifier fan heater on an incline plane.
- Only use the purifier fan heater on a horizontal and stable surface.
- Do not leave the purifier fan heater unattended. Always switch the purifier fan heater OFF at the controls and at the power outlet then unplug the purifier fan heater from the power outlet when not in use.

- Do not operate purifier fan heater whilst asleep.
- Do not operate the purifier fan heater with a damaged cord or plug, or if the purifier fan heater has been dropped or damaged in any matter, return the purifier fan heater to your nearest Breville service centre for examination, electrical or mechanical adjustment or repair.
- Do not operate the purifier fan heater with the power cord damaged, frayed or split, wound around any part of the purifier fan heater, or in contact with heated surfaces of the heater.
- Do not run the cord under carpeting or cover the cord with rugs, runner or the like. Arrange the cord away from traffic areas and where it will not be tripped over.
- Do not locate the purifier fan heater immediately below socket outlet when in use.
- Do not use this purifier fan heater with a programmer, timer or any other device that switches the purifier fan heater on automatically since a fire risk may exist if the purifier fan heater is covered or positioned incorrectly.
- This purifier fan heater is not intended for use in wet or moist locations.
- To disconnect the purifier fan heater, switch the power switch to OFF, then switch off at the power outlet then remove plug from the outlet.
- Do not insert or allow foreign objects to pass through the inlet or outlet openings. This may cause an electric shock, fire or damage the purifier fan heater.
- To prevent a possible fire or heat damage, allow ample space around the purifier fan heater (at least 1.7m at the front, 0.5m at the rear, top and sides) and do not totally or partially block the air inlet or outlets in any manner. Check the openings from time to time for accumulated dust. Ensure long shag carpet does not obstruct airflow under the unit.
- Do not touch hot surfaces or the front grill when in operation or for some time after, as these surfaces may be hot.
- Switch the purifier fan heater to OFF, then turn off at the power outlet and unplug. Allow the purifier fan heater to cool down before cleaning or storing.

- Do not operate the purifier fan heater on a sink or drain board.
- To avoid an electrical overload, it is recommended that no other appliances are plugged into the same circuit as your purifier fan heater when it is in use.
- Do not move the purifier fan heater when it is switched on.
- Do not use outdoors. This purifier fan heater is not intended for commercial use such as construction sites.
- Use this purifier fan heater only as described in this instruction manual. Any other use not recommended by the manufacturer may cause fire, electric shock or injury and void all warranties.
- Regularly inspect the supply cord, plug, control settings, air inlets and outlets and main housing for any damage. If found damaged in any way, immediately cease use of the purifier fan heater and return to Breville or an authorized service agent for inspection or repair.
- Do not unplug the purifier fan heater by pulling on the power cord. Always unplug using the power plug.
- To disconnect the purifier fan heater, switch the heater to OFF, then switch off at the power outlet and remove the plug from the power outlet. Allow the purifier fan heater to cool down before cleaning and storing.
- Keep the purifier fan heater and filter clean. Follow the cleaning instructions provided in this book.
- To prevent a possible fire or heat damage in heating mode, do not operate the unit remotely using the Breville Home Connect™ app when the unit is unattended.

IMPORTANT SAFEGUARDS FOR ALL ELECTRICAL APPLIANCES

- Fully unwind the power cord before use.
- Connect only to a 230V or 240V power outlet.
- Do not let the power cord hang over the edge of a bench or table, touch hot surfaces or become knotted.
- To protect against electric shock, do not immerse the power cord, power plug or appliance in water or any other liquid or allow

moisture to come in contact with the part, unless it is recommended in the cleaning instructions.

- The appliance is not intended for use by persons (including children) with reduced physical, sensory or mental capabilities, or lack of experience and knowledge, unless they have been given supervision or instruction concerning use of the appliance by a person responsible for their safety.
- Children should be supervised to ensure that they do not play with the appliance.
- It is recommended to regularly inspect the appliance. To avoid a hazard, do not use the appliance if power cord, power plug or appliance becomes damaged in any way. Return the entire appliance to the nearest authorized Breville service centre for examination and / or repair.
- Any maintenance other than cleaning should be performed at an authorised Breville Service Centre
- This appliance is for household use only. Do not use this appliance for anything other than its intended use. Do not use in moving vehicles or boats. Do not use outdoors. **Misuse may cause injury.**
- The installation of a residual current device (safety switch) is recommended to provide additional safety protection when using electrical appliances. It is advisable that a safety switch with a rated residual operating current not exceeding 30mA be installed in the electrical circuit supplying the appliance. See your electrician for professional advice.
- During electrical storms, the appliance should be disconnected from the power source at the wall socket to prevent any electrical surges that may arise during the storm and which may inadvertently cause damage to the appliance and its electronic componentry.
- Always turn the appliance to the OFF position, switch off at the power outlet and unplug at the power outlet when the appliance is not in use.

- Before cleaning, always turn the appliance to the OFF position, switch off at the power outlet, unplug at the power outlet and remove the power cord, if detachable, from the appliance and allow all parts to cool.
- Do not place this appliance on or near a heat source, such as hot plate, oven or heaters.
- Position the appliance at a minimum distance of 1m away from walls, curtains and other heat or steam sensitive materials and provide adequate space above and on all sides for air circulation.

**FOR HOUSEHOLD USE ONLY
SAVE THESE INSTRUCTIONS**



Components

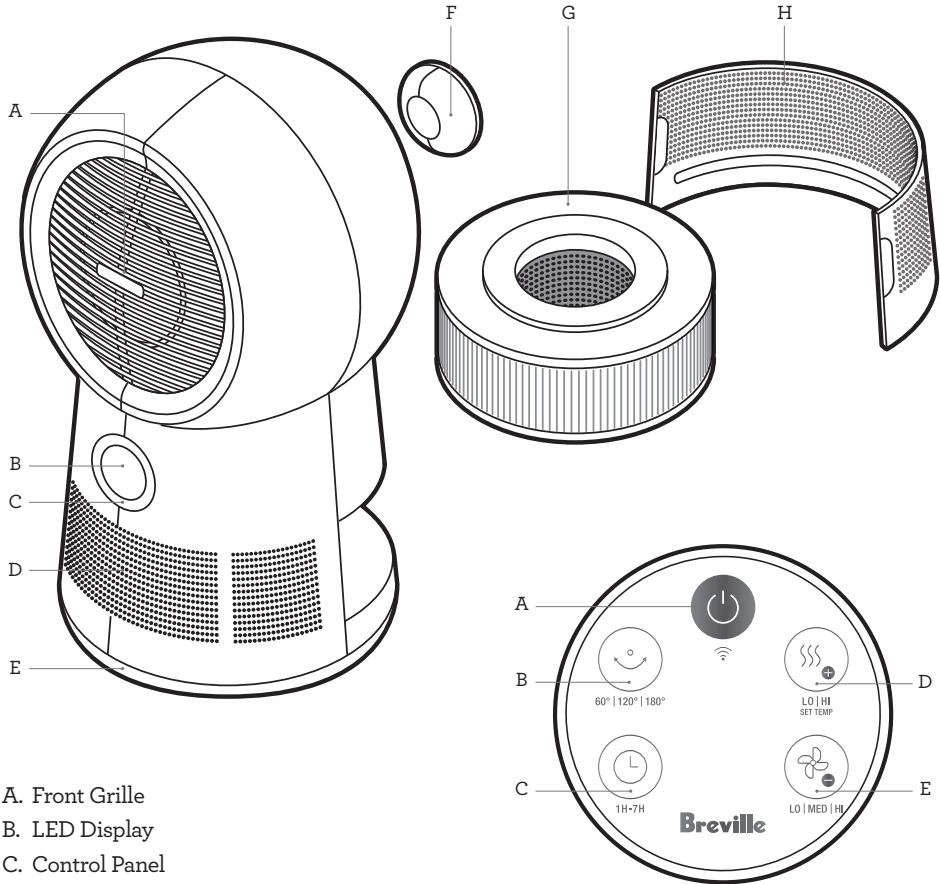

- A. Front Grille
- B. LED Display
- C. Control Panel
- D. Front Vent (air inlet)
- E. Oscillating Base
- F. Remote Control
- G. 3- Layer Filter
- H. Removable Back Vent (rear cover)

NOT PICTURED

- Power Cord and Plug
- Remote Control Storage
- Non-Slip/Non-Marking Rubber Feet

REMOTE CONTROL PANEL

- A. Power ON/OFF & Wi-Fi button
- B. Oscillation 60°C, 120°C & 180°C
- C. Timer (up to 7 hours) button
- D. Heating LOW/HIGH, Temp Increase & Set Temp button
- E. Cooling LOW/MEDIUM/HIGH & Temp decrease button



Control Panel

OUTER CONTROL PANEL

- A. Power ON/OFF & Wi-Fi button
- B. Timer (up to 7 hours) button
- C. Oscillation 60°C, 120°C, 180°C & Filter Reset button
- D. Cooling LOW/MEDIUM/HIGH, temp decrease & Child Lock button
- E. Heating LOW/HIGH, temp increase & Set Temp button

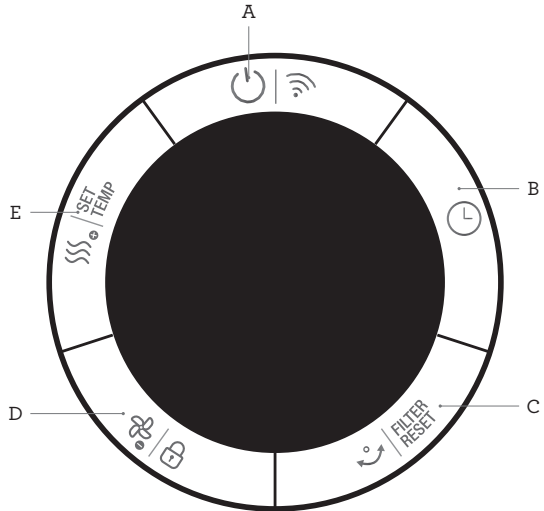

DISPLAY SCREEN

- A. Timer (up to 7 hours)
- B. Oscillation 60°C, 120°C, 180°C
- C. Cooling LOW/MEDIUM/HIGH
- D. Heating LOW/HIGH
- E. Child Lock
- F. Ambient / Set Temperature Display
- G. Replace Filter

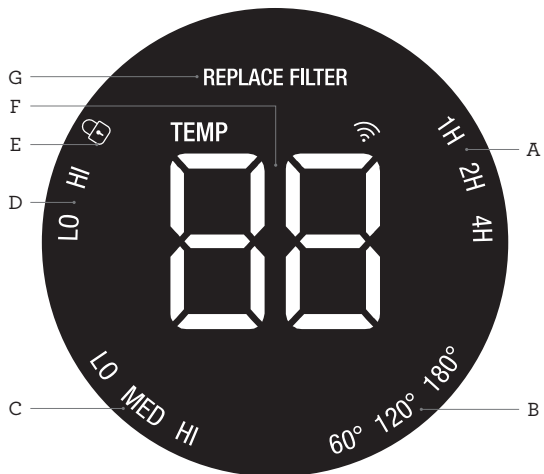



Features

WHAT IS THE AIRROUNDER™ CONNECT PURIFIER FAN HEATER?

The Breville AirRounder™ Connect purifier fan heater features an air purifier, heater and cooling fan in one.

The Purifier improves your indoor air quality using 3 distinct levels of protection.

1. A Pre-Filter

Captures larger airborne particles such as human hair, pet dander and dust particles.

2. A True HEPA Filter

Traps up to 99.97% of fine particles, allergens and airborne contaminants down to 0.3 microns in size. These include bacteria, viruses, mould spores, plant spores, and pollen.

3. An Activated Carbon Membrane

Along with assisting in the capture of dust, smoke, pollen and other airborne allergens, the activated carbon membrane helps to neutralise odours in the home and to eliminate fumes emitted by household products as well as other volatile organic compounds (VOC's) that might be found in the air.

SAFETY FEATURES

Safety Tip-Over Cut-Out Switch

There is a tip-over switch inside the purifier fan heater.

If the purifier fan heater is accidentally tipped over, the purifier fan heater will stop operating. Once placed back into the upright position, the purifier fan heater will switch on again.

THERMOSECURE™ Protection

Your purifier fan heater is fitted with a safety device that switches off the purifier fan heater in the event of overheating. Should this purifier fan heater stop working, turn off the purifier fan heater and inspect the air inlet and outlet for blockages. Wait until the purifier fan heater is fully cooled for the protection system to reset before attempting to restart the purifier fan heater. If the purifier fan heater fails to operate or the safety device switches off again, take the purifier fan heater to an authorised Breville Service Centre for examination or repair.



Assembly

BEFORE FIRST USE

- Remove and safely discard any packaging material or promotional labels attached to your purifier fan heater and filter. Check for any missing or damaged parts as per the components list.
- Remove the filter from the purifier fan heater (see REPLACING THE FILTER on page 19) and take it out of the plastic bag. Then reinsert the filter into the purifier fan heater.
- Select a flat and level location for the purifier fan heater
- For proper air flow, locate the unit at least 20cm from any wall or furniture.
- Ensure the air inlet and outlets are not blocked before use.
- Ensure the filter has been fitted correctly as per the instructions in this book.
- Plug the power plug into a 230V or 240V power outlet and turn on the power outlet.



WARNING

Remove the filter packaging before first use.



IMPORTANT



When moving the purifier fan heater, always lift the unit using two hands and set down gently on a flat and level surface.



Functions

OPERATING YOUR PURIFIER FAN HEATER

Place the purifier fan heater on a flat surface. Insert the power plug into a 230V or 240V power outlet and switch on at the outlet. When switched on, a chime will sound to confirm the unit is switched on and it is in standby mode.

1. Press the  button on the control panel or remote control to turn the purifier fan heater on. When switched on for the first time, the purifier fan heater will start automatically in heating mode, at high heat level and 25°C as the default set temperature will illuminate on the LED display.
2. To turn the purifier fan heater off at any time, press the  button on the control panel or remote control. When switched off, a chime will sound to confirm the unit is switched off and in standby mode.
3. To adjust how the purifier fan heater operates, follow the directions below.



NOTE

When the purifier fan heater is on and correctly setup to the Wi-Fi network, Wi-Fi will attempt to connect automatically. If a connection has been made, the Wi-Fi symbol will flash for 60 seconds, after 60 seconds, the Wi-Fi symbol will illuminate on the LED display. If a connection is not made, the Wi-Fi symbol will stop illuminating. See Wi-Fi Connectivity in this book for more details.

ROOM AMBIENT TEMPERATURE

To help maintain a comfortable environment, your Breville Air Rounder™ Connect purifier fan heater is fitted with a temperature sensor that detects the room temperature (in °C) which will display on the LED display screen. The number displayed is only an indication of the room temperature and will vary depending on the location of the purifier fan heater in the room.



NOTE

The room temperature display is an indicative temperature only based on the temperature sensor within the purifier fan heater. Temperatures further away from the unit itself may be different to this reading.



MEMORY

The purifier fan heater has a memory function and will return to the last setting it was set to when it was turned off. This will only occur if the purifier fan heater is not unplugged and/or switched off at the power point.

FUNCTIONS



Cooling Mode

Your purifier fan heater has 3 cooling fan settings: LOW, MEDIUM and HIGH.

1. To choose between these cooling fan settings, press the  button found on the control panel or  button found on the remote control, until the desired setting illuminates on the LED display screen. The LED display screen will display the room ambient temperature and current fan setting.
2. To cancel a cooling setting, press the  button to stop operation. If the operation is stopped, the unit will enter standby mode and the LED display screen will be dimmed and display the ambient room temperature.

Heating Mode

Your purifier fan heater has 2 heat settings LOW and HIGH and allows you to set your desired temperature with the default temperature setting at 25°C.

1. To choose between these heat settings, press the  **SET TEMP** button found on the control panel or  button found on the remote control repeatedly, until the desired setting illuminates on the LED display screen.
2. To cancel a heat setting, press the  button to stop operation. If the operation is stopped, the unit will enter standby mode and the LED display screen will illuminate 'OFF' whilst the unit is cooling down.







WARNING

To avoid overheating, do not cover the heater.

Set Temp

Take control of your room temperature. Everyone's comfort levels are different, so you can set your own preferred temperature or even heat the room before you go to bed.

1. To set the desired temperature, press and hold the  **SET TEMP** button found on the control panel or press and hold for 3 seconds the button found on the remote-control.
2. To increase the temperature press  **SET TEMP** button repeatedly on the control panel or  button repeatedly on the remote control.
3. To decrease the temperature press  button repeatedly on the control panel or  on the remote control.
4. Once the temperature has been set, the LED display screen will illuminate the room ambient temperature. The purifier fan heater will maintain the room ambient temperature to the temperature setting automatically.



NOTE

Choose the heat setting to determine to determine how quickly purifier fan heater will maintain the set temperature setting.



NOTE

When the purifier fan heater is turned on from standby, the memory function will start heating based on the previously set temperature and heating setting.



NOTE

When operating the purifier fan heater remotely in heat mode, the purifier fan heater will automatically switch off after 7hrs by default.



NOTE

The purifier fan heater will stop heating when ambient temperature is greater than set temperature (e.g. ambient > set temperature 25°C). Ambient temperature will flash and the LED display will stay the same and oscillation will stop.

The unit will start heating again when ambient temperature is less than set temperature (e.g. ambient temperature < set temperature 25°C). Ambient temperature will stop flashing and oscillation will resume at the same angle as previously set, only if the oscillation button is pressed on the control panel or on the remote control.

Night Mode

Your purifier fan heater is fitted with a light-sensitive sensor that will intelligently stop the LED display screen from illuminating at night when in a dark place.

The Night mode will automatically turn off all lights on the LED display panel and operate in the last setting.

Press any button on the control panel or remote control to re-engage the LED display panel.

TIMER

AUTO-OFF TIMER

The purifier fan heater comes with a 7-hour auto-off timer to turn off after a set number of hours.

The purifier fan heater can be set in 1 hour increments up to 7 hours. After the selected number of hours have elapsed, the purifier fan heater will switch to standby mode. If no timer is set, the purifier fan heater will continuously operate until it is manually switched off.

AUTO-OFF TIMER Example: Set the auto-off timer to 3 hours, and the purifier fan heater will stop operating after 3 hours. 1h and 2h will illuminate on the LED display screen.

The auto-off timer can be set in any MODE.

To set the timer, press the  button repeatedly on the control panel or the remote control until the desired number of hours displays on the LED display screen. The time will display on the LED display screen. The timer will start on the selected mode, and will stop automatically once the timer has expired.

The LED display screen will display the remaining auto-off time.

REMAINING TIME Example: Set the auto-off timer to 3 hours, once 1 hour has elapsed, the remaining time will be displayed in a decremental way, whereby 2h will only illuminate on the LED display screen, after another hour has elapsed 1h will illuminate on the LED display and so on and so forth until the set time has completely elapsed.

To cancel the pre-set auto-off time, once the timer is set, press the  button repeatedly on the control panel or the remote control until the number of hours no longer illuminates on the LED display.

NOTE

The timer can be set on all modes and all modes can be adjusted at any time once the timer is set.

The purifier fan heater will switch to standby mode once the set time has elapsed.

OSCILLATION

The purifier fan heater has horizontal oscillation. The oscillation can be set on all modes.

To activate oscillation, press the  button repeatedly on the control panel or the remote control to select between 60, 120 and 180 degrees, until the desired degree of oscillation displays on the LED display screen. The purifier fan heater will move left to right continuously.



To stop and direct the orientation of your purifier fan heater during oscillation, when the airflow has reached your preferred position, press the  button repeatedly on the control panel or the remote control until 60, 120 or 180 degrees is no longer illuminating on the LED display screen.

When the purifier fan heater is turned off, the unit will stop oscillating and return to centre position.

When turned on from standby, the purifier fan heater will start oscillating at the same angle as previously set. If no oscillation angle was set, the unit will stay at the same position as it was when it stopped

CHILD LOCK

When the Child Lock is engaged, the buttons on the control panel are locked from use.

1. To turn on, press and hold the  button on the control panel or press and hold the  on the remote control until a beep sounds and the child lock icon illuminates on the LED display panel.
2. To cancel, repeat step 1 until the child lock icon no longer illuminates on the LED display panel.

FILTER RESET

- The **REPLACE FILTER** icon will illuminate on the LED display panel indicating that the filter needs to be replaced.
- Replace the filter according to the directions found under Replacing the Filter in this book.
- Once the filter is replaced, press and hold the  button on the control panel for 10 seconds to reset. The **REPLACE FILTER** icon will no longer illuminate on the control panel display.
- The built-in timer for the filter reset is 4,320 operating hours.



NOTE

For best performance, the filter should be cleaned at least monthly as per the instructions found in the Care, Cleaning & Storage section of this book.

REMOTE CONTROL

The purifier fan heater comes with a remote control. This remote control features the same controls as the control panel on the purifier fan heater and can be used the same way.

The control panel has an additional control not found on the remote control. The **FILTER RESET** function can be set using the control panel only. Refer to the **FILTER RESET** section of this book for more details.

To avoid misplacing your remote control, place the remote control in the remote holder at the back of the unit (Fig. 1).

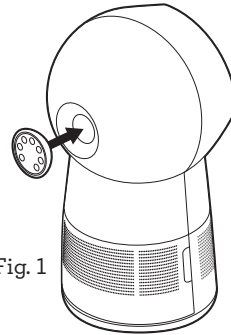

Fig. 1

USING THE REMOTE CONTROL

The remote control includes 1 x CR2032 3V Lithium battery. This Lithium battery is protected by an isolating slip. Before first using the remote control, remove the battery isolating slip by pulling the slip outwards away from the remote control.

To check and/or to replace the battery, open up the battery compartment at the back of the remote by forming a good grip of the remote, pushing the small arched groove to the right and simultaneously pushing out the battery compartment cover by pushing the rectangular groove outwards. Insert the battery paying attention to the polarity (+ and -) (Fig. 2).

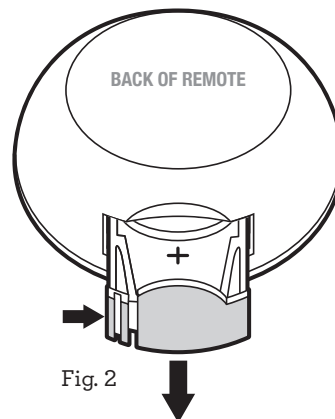

Fig. 2

Reinsert the battery compartment into the remote control ensuring that the + symbol is facing downwards when inserted. Make sure the battery compartment is correctly secured (Fig 3).

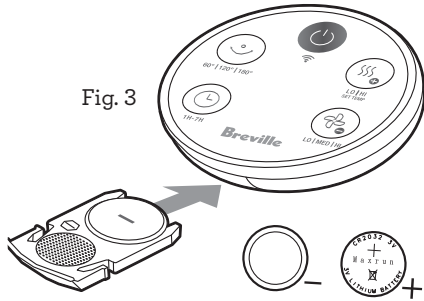

Fig. 3



NOTE

To use the remote control, it must be pointed at the control panel and must be used within five meters of the unit



WARNING

KEEP BATTERIES OUT OF REACH OF CHILDREN

Swallowing may lead to serious injury in as little as 2 hours or death, due to chemical burns and potential perforation of the oesophagus. If you suspect your child has swallowed or inserted a button battery immediately call the 24-hour Poisons Information Centre on 13 11 26 for fast, expert advice. Examine devices and make sure the battery compartment is correctly secured, e.g. that the screw or other mechanical fastener is tightened. Do not use if compartment is not secure. Dispose of used button batteries immediately and safely. Flat batteries can still be dangerous. Tell others about the risk associated with button batteries and how to keep their children safe.



Wi-Fi Connectivity

The Breville AirRounder™ Connect purifier fan heater can offer remote operation by using a home Wi-Fi connection and the Breville Home Connect™ app downloaded to a compatible mobile phone, through the Google Play store or Apple App store.

To go straight to the appropriate app store, scan the QR code below.



For instructions on how to use the app, scan the QR code below, refer to the Quick Start Guide that can be found in the box or go to tinyurl.com/HomeConnectQuickStart.



NOTE



The Breville Home Connect™ app is compatible with mobile phones running Android® 5.0 or later and iOS devices 9.0 or later.





NOTE

To control the purifier fan heater using the app, the purifier fan heater must be plugged in to an active power outlet and turned on.

CONNECT YOUR PURIFIER FAN HEATER TO WI-FI

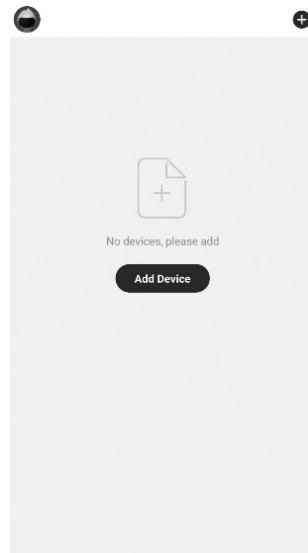
1. Ensure the mobile device is connected to a home Wi-Fi network.
2. The purifier fan heater can either be on standby mode or turned on when setting up. The symbol  will flash fast on the display panel. The purifier fan heater is now ready to connect. The symbol stops flashing after 60 seconds but pairing remains possible.
3. Log into your Breville Home Connect™ app account and stay on the “Home” page. To add the purifier fan heater to the list. Touch ‘Add Device’ or the  symbol found in the top right-hand corner of the screen. Follow the prompts in the app.



4. If the connection is successful, the purifier fan heater will appear in the main page of the app and the  symbol light on the purifier fan heater will illuminate.
5. If unsuccessful, press and hold the button  for 3 seconds until the symbol is flashing slowly. Follow the prompts in the app to connect in a different mode.



Care, Cleaning & Storage

The purifier fan heater and filter should be cleaned at least once every month. Ensure the purifier fan heater is switched off and disconnected from the power outlet and allow all parts to cool before cleaning or storing.

- Use a clean, dry cloth to clean all external surfaces of the purifier fan heater.



NOTE

More frequent cleaning may be required depending on environmental conditions.

BREVILLE RECOMMENDS

- Always ensure the purifier fan heater is turned off, switched off at the power outlet and unplugged and allow the unit to cool before performing any cleaning or filter replacement.
- ✘ **DO NOT** stick any foreign objects or your fingers inside the air inlet/outlet of this unit.
- ✘ **DO NOT** use gasoline, benzine, thinner, harsh cleaners, etc. on and/or in the unit while cleaning as they will damage the unit.
- ✘ **NEVER** use alcohol or other solvents on this unit.

FILTER CARE & CLEANING



WARNING

The filter is not washable. Do not immerse any part of the air purifier in water as it will cause damage.

- The Pre-filter should be cleaned at least once every month using a vacuum cleaner. Gently vacuum using a hand-tool attachment such as a brush or upholstery tool. Clean more often if required (Fig 4).

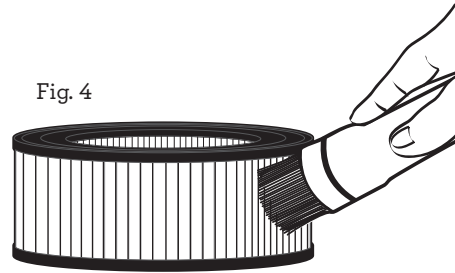

Fig. 4

- Do not attempt to clean the carbon filter with a vacuum as this can cause damage.
- Do not use any solutions, hard bristle brushes or sharp objects to clean as this can cause damage.
- Replace the filter as indicated using the following instructions.

REPLACING THE FILTER

Your AirRounder™ Connect purifier fan heater filter should be replaced in the time frames indicated below. The filter life is approximately 6 months if used 24 hours daily, or 12 months if used 12 hours daily.

- The filter life may vary to this timing depending on environmental conditions.
- Remove all packaging from the replacement filter and place the filter into the unit as described below.

1. Remove the rear housing cover (Fig 5).

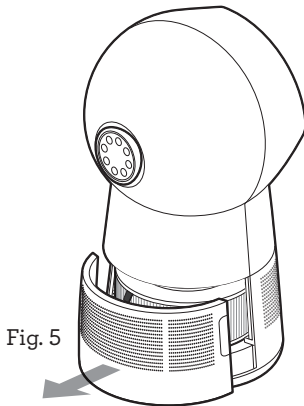

2. Remove the used filter using the pull tabs on the filter (Fig 6).

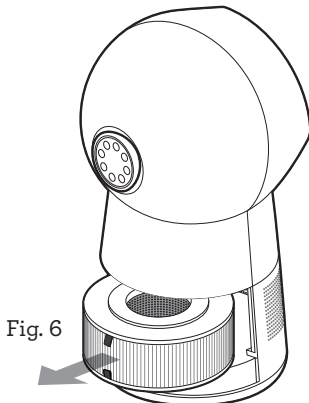

3. Remove all packaging from the replacement filter then place into the purifier fan heater with pull tabs facing the opening (Fig 7).

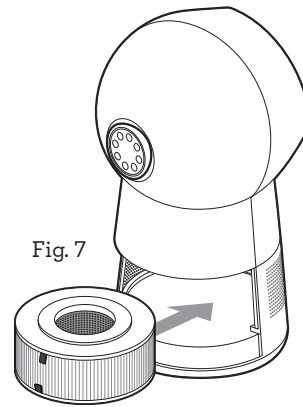

4. Ensure the filter is correctly fitted.
5. Replace the rear housing cover (Fig 8).

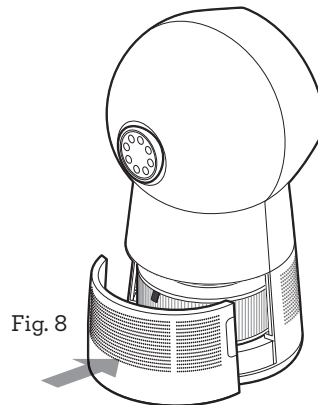

Press and hold the  button on the control panel for 10 seconds to reset the filter. **REPLACE FILTER** icon will no longer illuminate on the LED display panel.

NOTE

There is no top or bottom on the filter. The filter can be placed into the unit either way.

NOTE

If the filter is not in place or not fitted correctly, the purifier fan heater will not operate.

REPLACEMENT FILTERS

Replacement filters must be purchased from the Breville website* or at participating retail outlets.

See the table below for the replacement product code to suit this Breville Purifier Fan Heater.

Breville Purifier Fan Heater Model No.	Filter Replacement Product Code
the AirRounder™ Connect LPH408WHT	LPH040WHT
the AirRounder Plus™ Connect LPH708WHT	LPH070WHT

*Delivery charges may apply.

Please contact Breville Customer Service Centre for further support.

Only use the original Breville filter specially intended for this appliance. Do not use any other filters.

STORAGE

When not in use, store the purifier fan heater upright in a cool, clean and dry location.



Troubleshooting

MINI TROUBLESHOOTING GUIDE

Before carrying out any of the following service checks, unplug the unit from the mains.

PROBLEM	WHAT TO DO
Unit will not start	<ul style="list-style-type: none">• Check that the power plug is connected to a power outlet and the outlet is turned on.• Check that purifier fan heater is assembled correctly.• Check that the filter is fitted correctly in place.
Insufficient air flow	<ul style="list-style-type: none">• Make sure the filter is removed from the packaging.• Check that the filters are clean.• Check for any obstructions in the air inlet and/or outlet.
Excessive noise	<ul style="list-style-type: none">• Check if the filter is clogged and ready for replacement.• Check that the rear housing cover is closed properly.• Check that the unit is on a level surface
Not heating in the heating mode	<ul style="list-style-type: none">• Check for any obstructions in the air inlet and/or outlet.• Surface temperature of the heating plate rises, and the thermostat has stopped working.
Filter Indicator is still illuminated after replacing the air filter	<ul style="list-style-type: none">• Reset the REPLACE FILTER indicator (see page 19).

Breville Customer Service Centre (see back cover for contact details)

BREVILLE HOME CONNECT™ APP TROUBLESHOOTING

PROBLEM	WHAT TO DO
Why can't I connect my purifier fan heater to Wi-Fi network?	<ul style="list-style-type: none">• Check that your purifier is within range of the Wi-Fi router• During the setup process you must be on a secure 2.4GHz Wi-Fi network.• Make sure the Wi-Fi password you entered is correct.• Check that the filter is fitted correctly in place.• Unplug the purifier for 10 seconds and plug it back in.
How do I change my Wi-Fi network to a 2.4GHz Wi-Fi network?	<ul style="list-style-type: none">• Most dual-band routers support both 2.4Ghz and 5Ghz networks. Select the Wi-Fi name that does not end in “-5G”• If your phone is attempting to connect to the 5Ghz network, try “forgetting” or temporarily disabling the 5Ghz network.• If you are unsure, or if the 2.4Ghz and 5Ghz networks do not have separate names, please contact your internet service provider.
I already have another appliance connected to the Breville Home Connect™ app, but my purifier fan heater won't connect?	<ul style="list-style-type: none">• Close and relaunch the Breville Home Connect™ app• Reset the Wi-Fi on the purifier fan heater by pressing and holding the power button for 3 seconds when in standby mode. The Wi-Fi indicator will rapidly blink and turn off.• Re-pair the purifier to the Breville Home Connect™ app by following the instructions in this booklet
My purifier fan heater is offline	<ul style="list-style-type: none">• Make sure your router is connected to the internet and your phone's network connection is working properly.• Check that your purifier is within range of the Wi-Fi router• Delete the offline purifier fan heater for the Breville Home Connect™ app. Swipe left (iOS) or tap and hold (Android), and tap Delete.• Reset the purifier fan heater by pressing and holding the power button for 15 seconds. The Wi-Fi indicator will rapidly blink 10 times and turn off.• Reconfigure your purifier fan heater with the Breville Home Connect™ app.• NOTE: Power outages, internet outages, or changing Wi-Fi routers may cause your air purifier to go offline.

If the problem is not listed, please contact Breville Customer Service Centre (see back cover for contact details)



Note

Breville Customer Service Centre

Australian Customers

Phone: 1300 139 798

Web: www.breville.com

New Zealand Customers

Phone: 0800 273 845

Web: www.breville.com

Breville®

Master Every Moment™

Breville, the Breville logo, Master Every Moment, AirRounder, ThermoSecure and Breville Home Connect are trademarks of Breville Pty. Ltd. A.B.N. 98 000 092 928.

Copyright Breville Pty. Ltd. 2020

Due to continued product improvement, the products illustrated/photographed in this booklet may vary slightly from the actual product.

LPH408 ANZ C20