

rite 1

SLOPING ROOF SHED

1530mm wide x 780mm depth x 1830mm - 1770mm high

BEFORE YOU BEGIN:

To avoid any confusion with your new shed build, we strongly suggest that you unpack and identify each part before you begin to put it together.

**THIS SHED
WAS PROUDLY
PACKED BY:**

Please quote this code
for any correspondence
back to the supplier

ASSEMBLY INSTRUCTIONS

YOU SHOULD HAVE ONE PACKAGE:

- 1 cardboard package

TOOLS REQUIRED:

- Battery or electric drill
- 3.3mm (1/8th inch) drill bit
- Screwdriver or riveter
- Tape measure
- Ladder
- Non-slip gloves, good shoes and goggles
- A set of helping hands

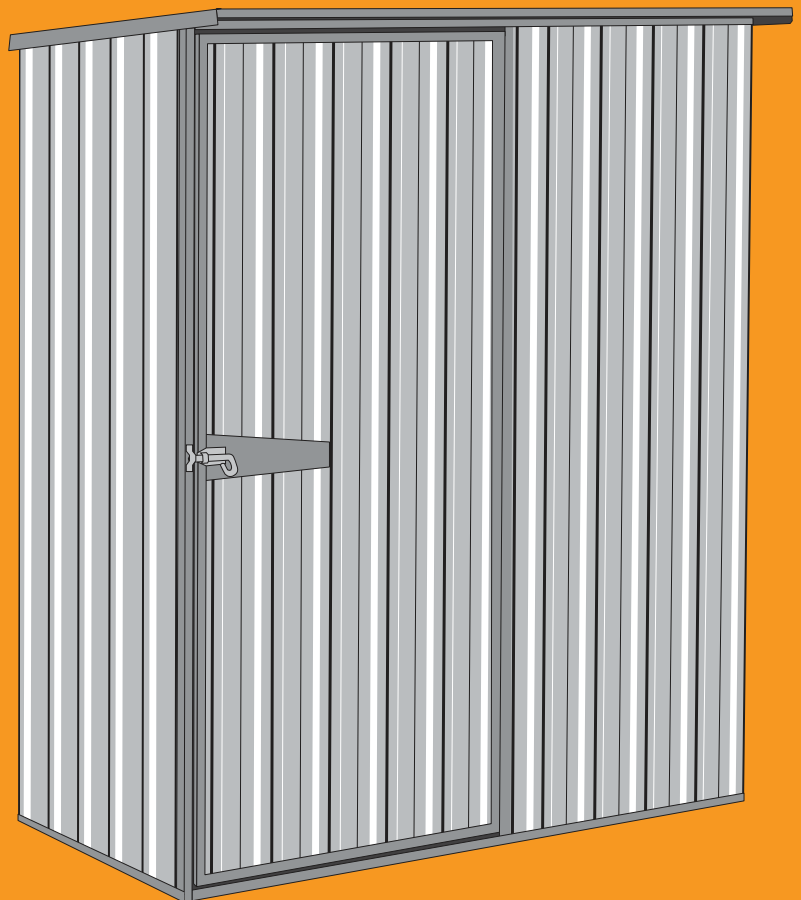

20
YEAR
WARRANTY



DOWNLOAD THE STORITE APP



SCAN TO
WATCH OUR
ASSEMBLY VIDEO

HERE

Some parts have sharp edges and should be handled very carefully.
We recommend the use of protective gloves and footwear when assembling.

DO NOT attempt to erect this shed in windy weather. All dimensions are approximate.



CALL 0508 454 873
for an installer near you

COMPONENTS CHECKLIST

Please check the parts carefully and advise immediately if any are damaged or missing.

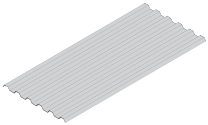
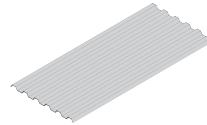
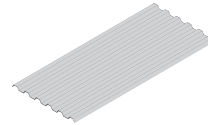
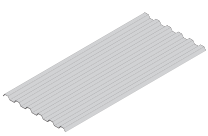
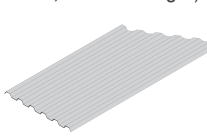
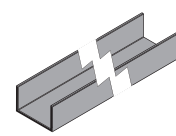
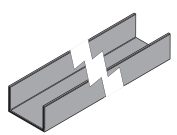
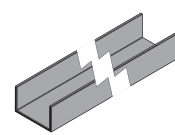
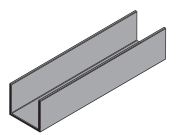
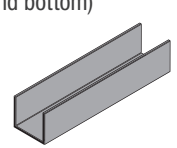
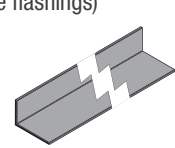
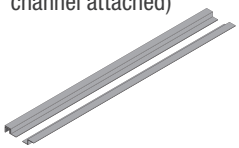
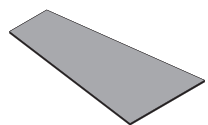
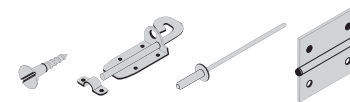
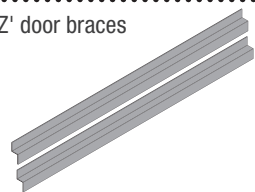
<p>A 1 x 1770mm x 780mm door sheet</p> 	<p>B 1 x narrow 1830mm x 715mm sheet for front wall, beside door</p> 	<p>C 2 x 1770mm x 780mm sheets for back wall</p> 
<p>D 2 x 980mm x 780mm sheets for roof</p> 	<p>E 2 x 1830mm - 1770mm sloping sheets (end walls, 1 left & 1 right)</p> 	<p>F 6 x 1515mm 'U' channels for front, back and roof</p> 
<p>G 4 x 735mm 'U' channels for side walls</p> 	<p>H 2 x 1770mm 'U' channels for door sides</p> 	<p>I 2 x 793mm 'U' channels (door spacers)</p> 
<p>J 2 x 780mm 'U' channels (door top and bottom)</p> 	<p>K 2 x 980mm 'L' flashings (roof to side flashings)</p> 	<p>L 2 x 1830mm 'Z' door jambs. (1 length has 'U' channel attached)</p> 
<p>M 1 x 310mm door plate</p> 	<p>N 1 x pack screws, rivets, padbolt and hinges</p> 	<p>O 2 x 'Z' door braces</p> 

IMPORTANT!

- Remove the swarf (drill filings) from the panels as you assemble them.
- All components are cut to length. Do not cut any parts unless instructed.
- Fixings through the inside of the channels into the sheeting are just as important as fixings from the outside.

RIBS AND PANS

- Generally most fixings are spaced at 300mm apart.
- Keep the fixings in the pans as close to the ribs as possible for added strength.
- Ribs will always protrude to the outside of the shed.
- Extra internal fixings are strongly recommended in high wind areas.
- Panel sizes may vary by up to 10mm.

You can construct your shed using either rivets or screws. Both types of fixing are supplied.

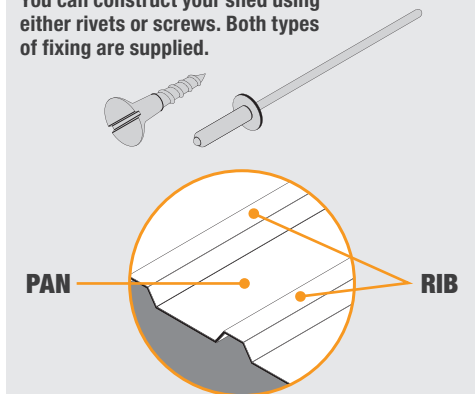

BUILDING YOUR SHED

- The basic task is to join the sheets together to form your panels, and fix channels to the top and bottom of these panels. They will then join together to form your shed (diagram 1, 2, and 3).

DIAGRAM 1

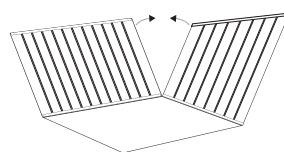

DIAGRAM 2

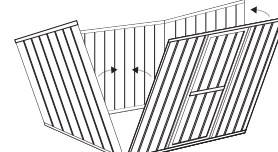
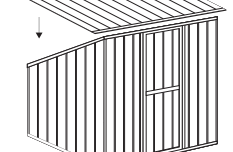

DIAGRAM 3



STEP 1 DOOR ASSEMBLY

Attach the 780mm 'U' channels **J** to the top and bottom of the door sheet **A** at the centre ribs only. Attach the 1770mm 'U' channels **H** to the door sheet **A** through the top and bottom channels **J** at the four corners. Attach the door plate **M** in the center of the door sheet, slipping it under the two side 'U' channels and fixing it to the sheet ribs and the side 'U' channels. Attach the hinges **N** approx 150mm from the top and bottom of the door through the 'U' channels. The fixings should be centred on the side 'U' channels.

Turn the door over and fix the four corners through all the 'U' channels.

Fit the door bracing from the bottom corner to the opposite centre to the top corner (see step 7 on page 6).

YOU WILL NEED

- A** 1 x 1770mm x 780mm door sheet
- H** 2 x 1770mm 'U' channels for door sides
- J** 2 x 780mm 'U' channels (door top and bottom)
- M** 1 x 310mm door plate
- N** Hinges
- O** 2 x 'Z' door braces

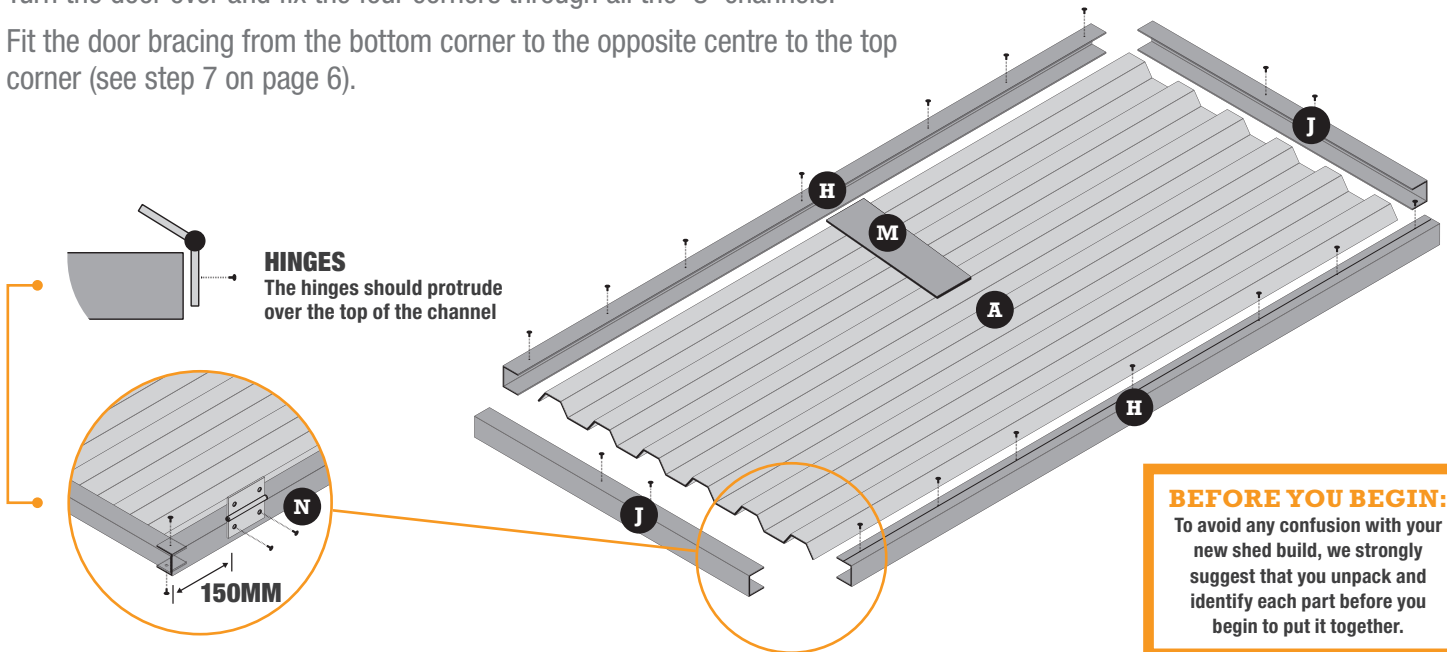

STEP 2 HANGING THE DOORS

Attach the first 'Z' door jamb **L** to the 715mm sheet **B** on the rib with the narrow pan. Attach the other 'Z' door jamb to the 715mm sheet **B**. Lay the premade door face down on the 715mm sheet **B** approx 30mm up from the bottom and down from the top. Check the door is centralised on the sheet (top and bottom). Fix the hinges through the side of the 'Z' door jamb **L** raising the door about 4mm off the 'Z' door jamb.

YOU WILL NEED

- B** 1 x narrow 1830mm x 715mm sheet for front wall
- L** 1830mm 'Z' door jambs, without channel attached

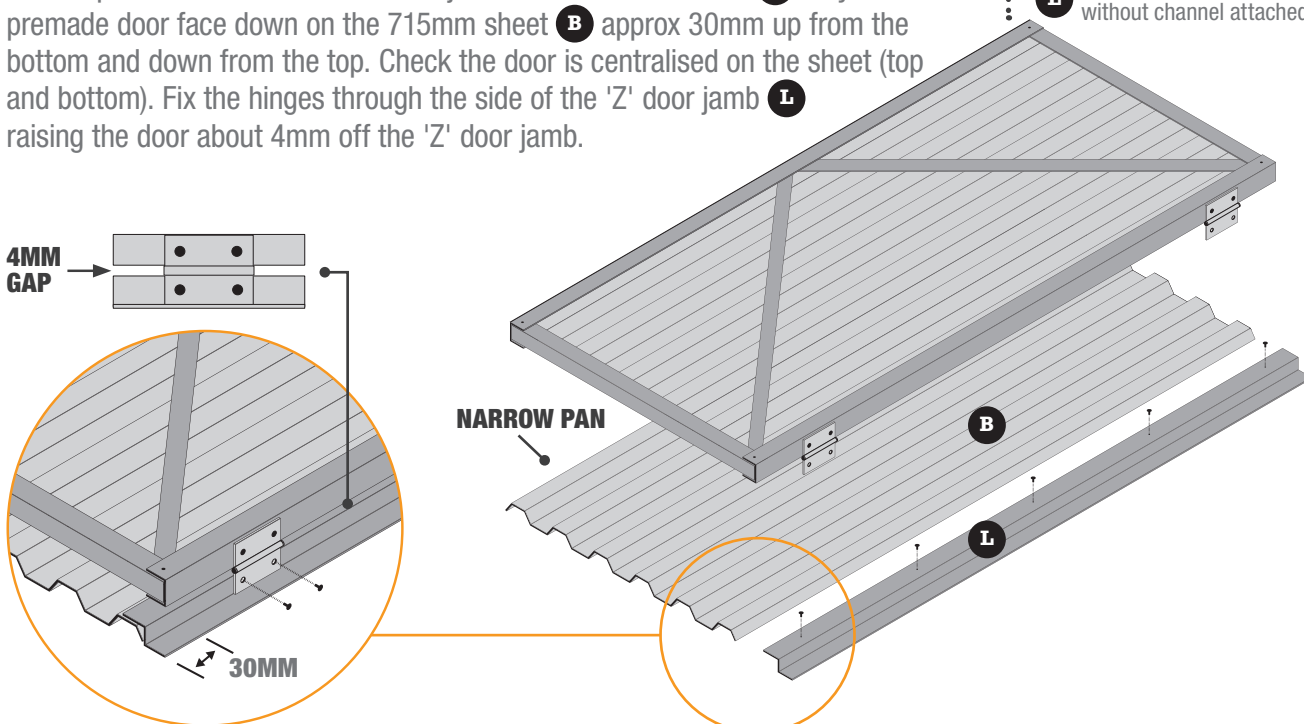

If you choose to vary from these instructions your warranty will be impaired.



If you need advice, contact the Mitre 10 store where you purchased your shed.

STEP 3 FRONT WALL

Lay out the door with the sheet attached and the corner door jamb with the 'U' channel attached **L**. (as shown below). Cap the sheets with the 1515mm channels **F**. Use the door spacers **I** to make sure the door fits the gap (they sit on top of the 'Z' door jambs **B**). Drill and fix (rivet or screw) the channels at every second rib down through the top. Attach the door spacers at each end through the 'Z' door jambs and channels.

Put three fixings underneath through the channels into the sheeting pan and the top and bottom of the door spacers and 'Z' door jambs (see diagram 1).

Fit the padbolt to the door strap on the outside of the door using wide flange rivets or screws.

YOU WILL NEED

- F** 2 x 1515mm 'U' channels
- I** 2 x 793mm door spacers
- B** 1 x 1830mm x 715mm sheet
- L** 'Z' door jambs (attached to B)
- N** Padbolt

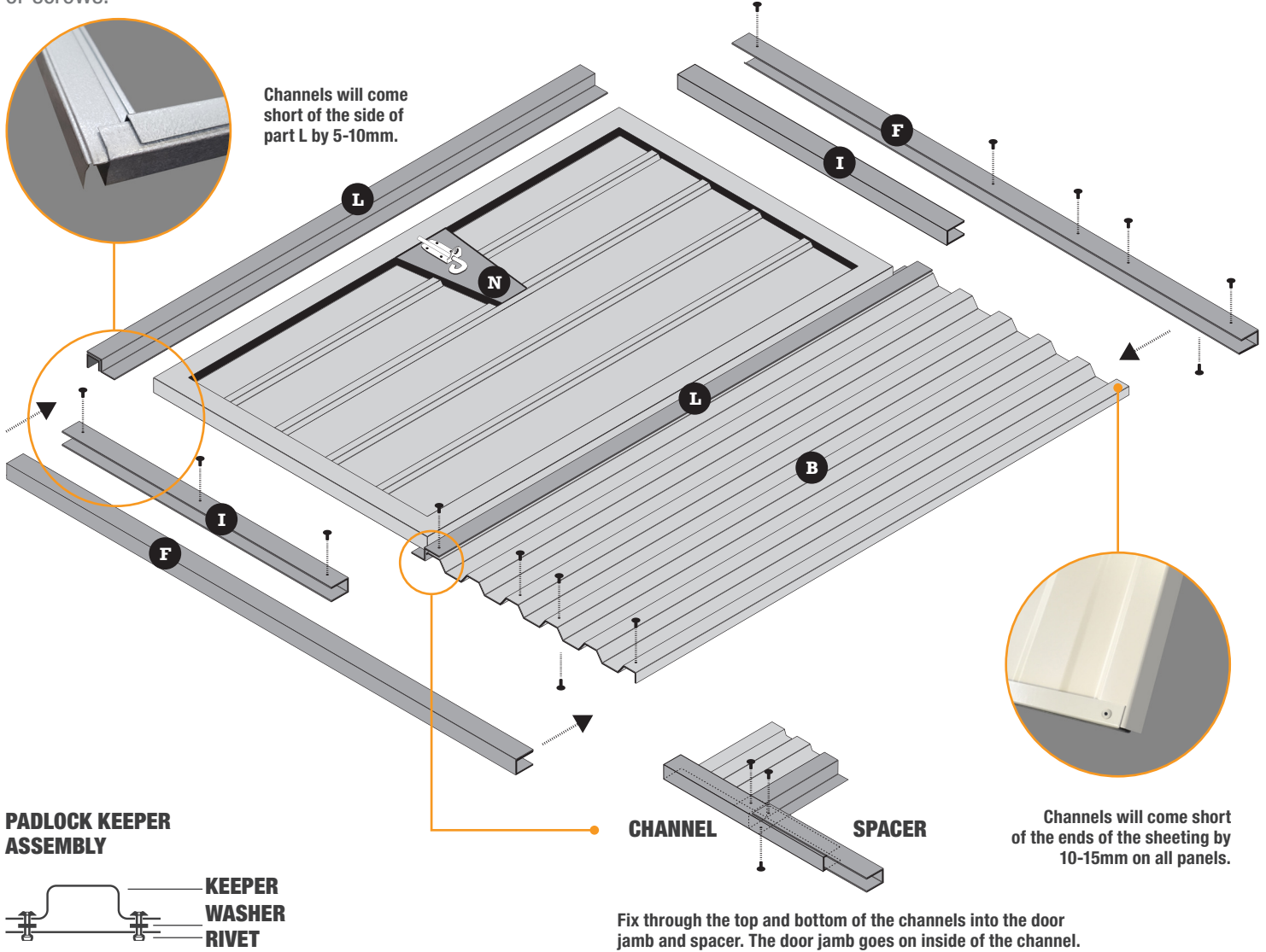

ADDITIONAL INFORMATION

CHANNELS

The higher side of the channel goes to the inside of the shed. It is very important to include the fixings on the underside of all the channels as they are structural (except roof channels).

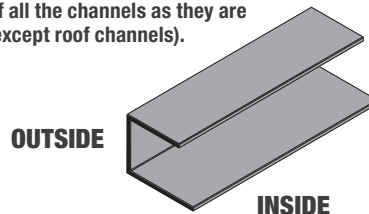

GET IT RIGHT TIP 1

To hinge the door on the opposite side, simply put the top channel on the bottom and the bottom on the top.

Put the padbolt on the door before erecting the panels. It will stop the door swinging around!

4



If you choose to vary from these instructions your warranty will be impaired.



If you need advice, contact the Mitre 10 store where you purchased your shed.

STEP 4 BACK WALL

Join the two sheets **C** together with 2 fixings through the overlapping ribs, making sure the ends of the sheets are flush. Cap the sheeting with the 1515mm 'U' channels **F**.

Fix the channels through the end ribs and every second rib in between.

Make sure you put at least one fixing per sheet up through the underside of the channel into the pan of the sheet.



SCAN TO
WATCH OUR
ASSEMBLY VIDEO
HERE

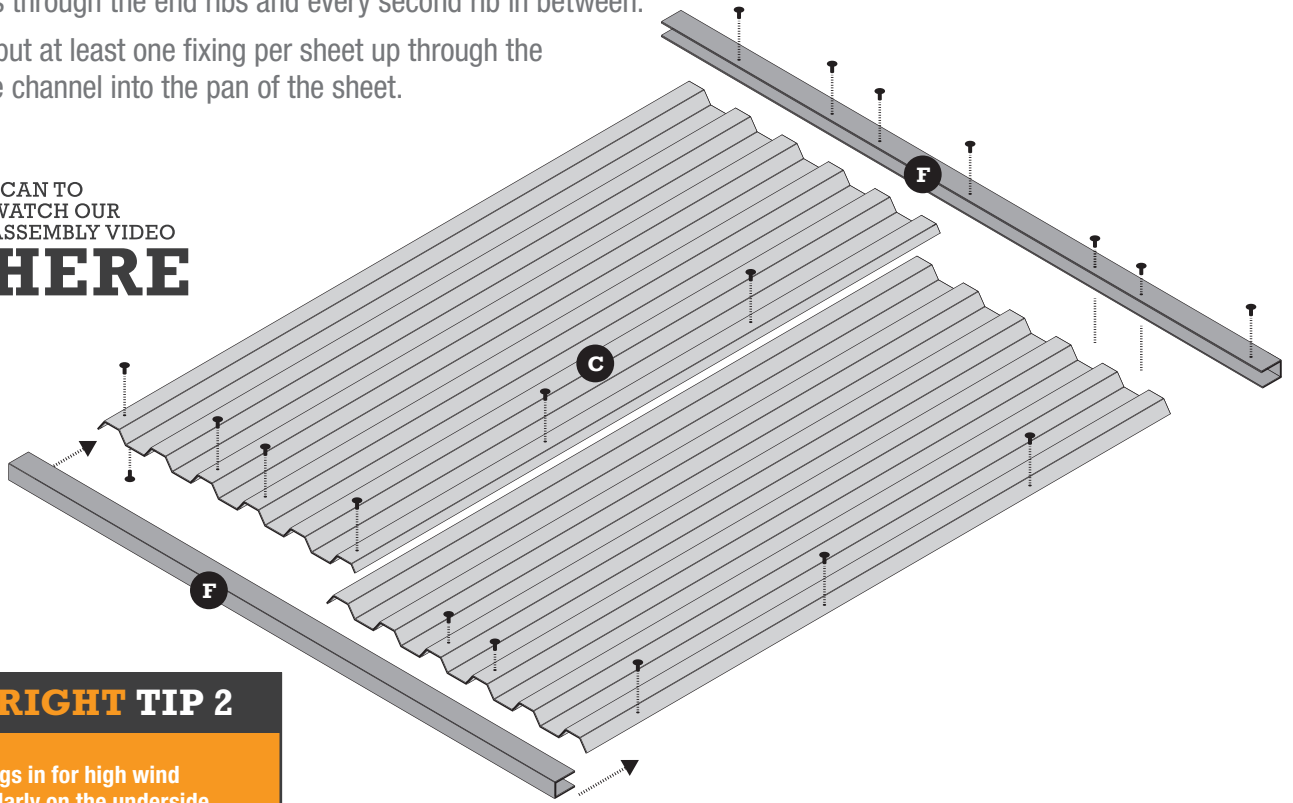

GET IT RIGHT TIP 2

Put extra fixings in for high wind areas, particularly on the underside.

STEP 5 ROOF

Join the two sheets **D** together (same as the back). Cap the sheeting with the 1515mm 'U' channels **F**. Fix the channels at every second rib but not the corners at this stage. Place the short flange of the first 'L' flashing **K** on top of the rib at one end. Make sure the ends are flush with the sheeting (diagram 1) and put one fixing in the centre to hold the 'L' flashing. Fix the corners through the channels and one more between the corner and the centre fixing. Perform the same at the other end. Use five fixings each 'L' flashing.

YOU WILL NEED

- D** 2 x 980mm x 780mm sheets
- F** 2 x 1515mm 'U' channels for the roof
- K** 2 x 980mm 'L' flashings

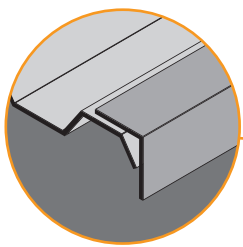
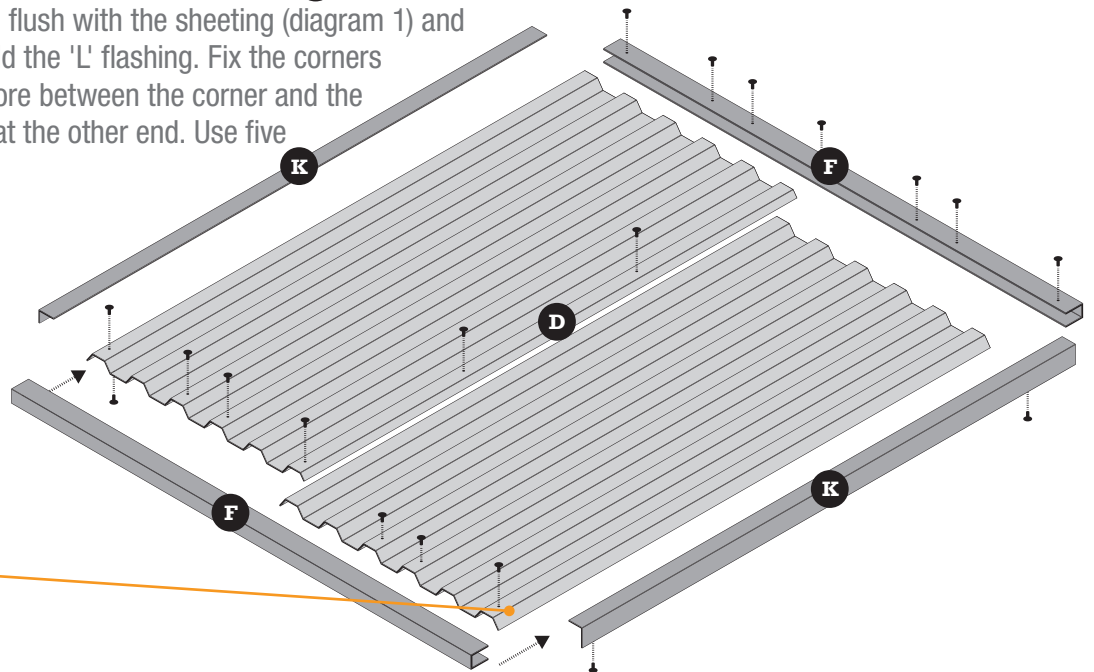

If you choose to vary from these instructions your warranty will be impaired.



If you need advice, contact the Mitre 10 store where you purchased your shed.

STEP 6 END WALLS

Cap the sloping sheets **E** with the 735mm 'U' channels **G**. Fix the channels through the end ribs and every second rib in between. Make sure you put at least two fixings up through the underside of the channel into the pan of the sheet.

Repeat for other side wall with opposite slope.

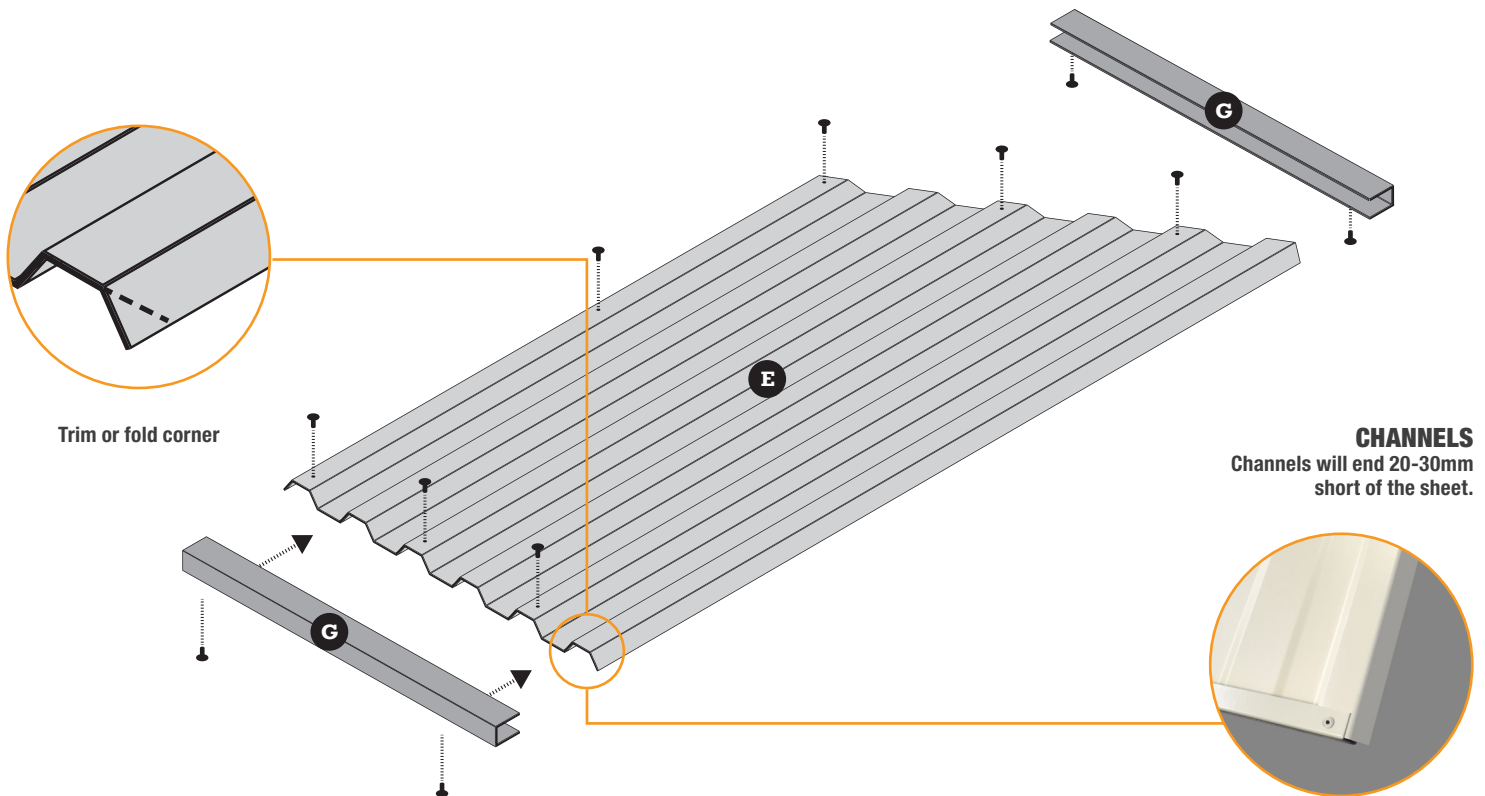

YOU WILL NEED

- E** 2 x 1830mm - 1770mm end walls
- G** 2 x 735mm 'U' channels per side

STEP 7 DOOR BRACES

The door braces can be fitted now or after you have assembled your shed. Tuck one end of the 'Z' between the bottom channel of the inside of the door and the sheet. Do the same at the top, overlapping in the centre behind the padbolt.

If you have a locking 'T' handle you will have to run the 'Z's the opposite way to the diagram.

Rivet the 'Z's at the ends, and in the centre of the channel it is tucked under, and through the overlap in the centre. Two or three more fixings will be required through the door sheeting into the 'Z', but they will need to be riveted through from the outside of the door for a neater appearance.

You may need to cut or bend the flange at the bottom and the top of the 'Z' if it catches on the door jamb when opening or closing (see diagram 1 below).

DIAGRAM 1
BEFORE

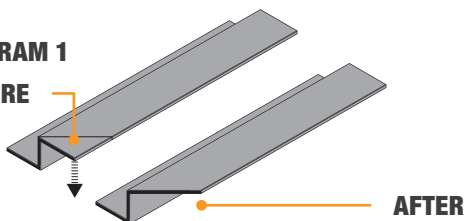

YOU WILL NEED

- O** 2 x 'Z' door braces
- N** Fixings



ABOVE:
Z door braces in position on the inside of door sheet

6



If you choose to vary from these instructions your warranty will be impaired.



If you need advice, contact the Mitre 10 store where you purchased your shed.

STEP 8 INSTALLATION

SIDE WALL ASSEMBLY

- Stand up the back wall and as your helping hand is holding it up, bring the left end wall in to meet it at the left corner (diagram 1) overlapping the corners (diagram 2). Drill and fix at approximately 100mm down from the top and up from the bottom, drilling and fixing from the outside.
- Bring the right end wall into the right back corner and perform the same again checking to make sure the walls are sitting flat at the bottom.
- Bring the front wall into place and join the front corners to the end walls, same as the back (diagram 3).
- Finish joining the corners by fixing at approximately 200-300mm apart. You will find it easier to drill these corners if they are supported on the inside (see tip).

FIXING THE ROOF

- With a person at each end of the roof, lift it over the top of your upright walls and lower down on top with an overhang that looks best to you (diagram 4). At the left end fix through the 'L' flashing into the top channel of the left end wall. Measure the overhang at the back and fix the right end 'L' to the right end wall with the same overhang as the left end. If it is difficult to get the same overhang at each end, this will be caused by an unlevel site or walls that are not square. Adjust accordingly. Fix the 'L's at 300mm apart.
- Using the ladder and the tape measure, fix down through the top of the roof, through the pan into the top channel of the front and the back walls (10mm more than the overhang). Fix beside every second rib. You will not need to worry about these fixings leaking as any water seeping through these fixings will end up on the outside of the walls.

FIT THE DOOR BRACES AND INSTALL SHED

- Fit the door braces, if not already done so. Check that all filings/swarf is removed.
- Important: Fix your shed down to its foundations. If your foundations are unlevel or bowed, you will have problems with your padbolt and door levels. This can be fixed by slipping a spade under either door jamb and lifting. You will soon get a feel for which side needs propping up.

IMPORTANT

- Do not attempt to assemble panels in rain or windy conditions.
- Make sure your foundations are squared and level before erecting panels.
- It is easier to remove all swarf (filings) before you stand your walls up.
- Complete all panels before erecting your shed.
- Keep a firm grip on panels when handling. If they slip they will cause damage.
- Always wear non-slip gloves, protective footwear and eyewear.

YOUR SHED'S FLOOR

- It is essential that every shed has a floor, but the only way to make sure your shed is there to stay on windy sites is with a recessed concrete floor.
- Visit your local Mitre 10 store for floor options

BUILDING YOUR SHED

The basic task is to join the sheets together to form your panels, and fix channels to the top and bottom of these panels.

They will then join together to form your shed (diagram 1, 2, 3 and 4).

DIAGRAM 1

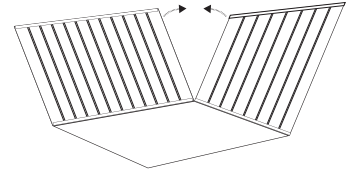

DIAGRAM 2

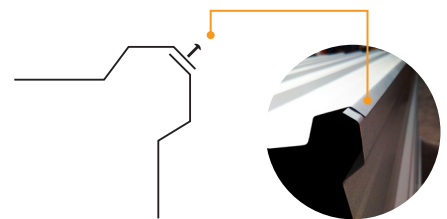

DIAGRAM 3

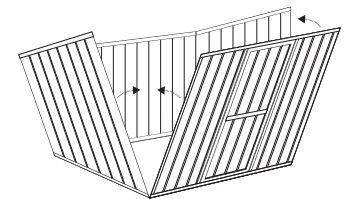
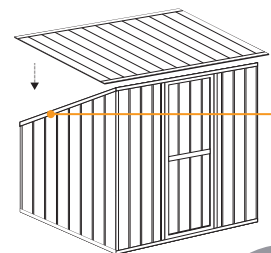

DIAGRAM 4



L FLASHING

Rivet through the side of the 'L' flashing to secure the roof to the side of the shed.

GET IT RIGHT TIP 3

Use the handle end of a hammer in the inside of the corner, but beware of drilling holes on the end of your hammer!



If you choose to vary from these instructions your warranty will be impaired.



If you need advice, contact the Mitre 10 store where you purchased your shed.

STEP 9 COMPLETE YOUR SHED

RECESSED CONCRETE FLOOR PLAN FOR SPECIALLY POURED CONCRETE FLOORS: SPECIFICATIONS

Every shed must have some type of foundation between it and the ground. You can pour a concrete floor and use recessed floor clamps, use an existing concrete base with flat floor clamps or purchase a kitset wooden floor from your local Mitre 10 store.

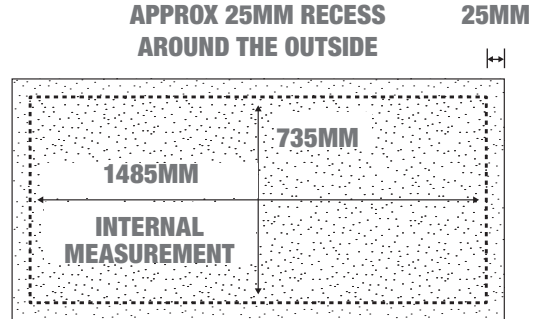
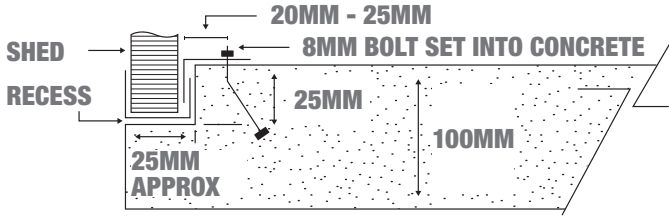

BOXING DIAGRAM

20MM - 25MM
(1' X 1')

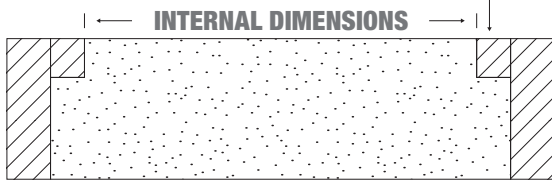

RECESSED FLOOR CLAMPS

For poured floors with a recess around the perimeter. Available from your local Mitre 10 store.

sku:295563

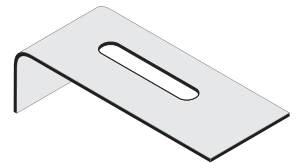

**INTERNAL DIMENSIONS
FOR THE RITE 1:
1485MM X 735MM**

FLAT FLOOR CLAMPS

For existing concrete only. Water can seep underneath. Available from your local Mitre 10 store.

sku:295564

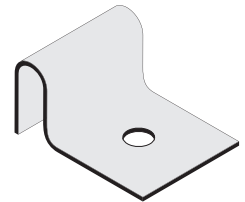

KITSET WOODEN FLOORS

Every shed must have a floor. These are available from your local Mitre 10 store. For more information visit www.mitre10.co.nz

sku:235439

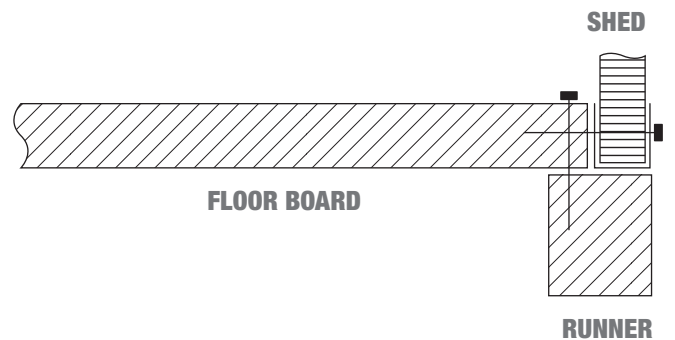
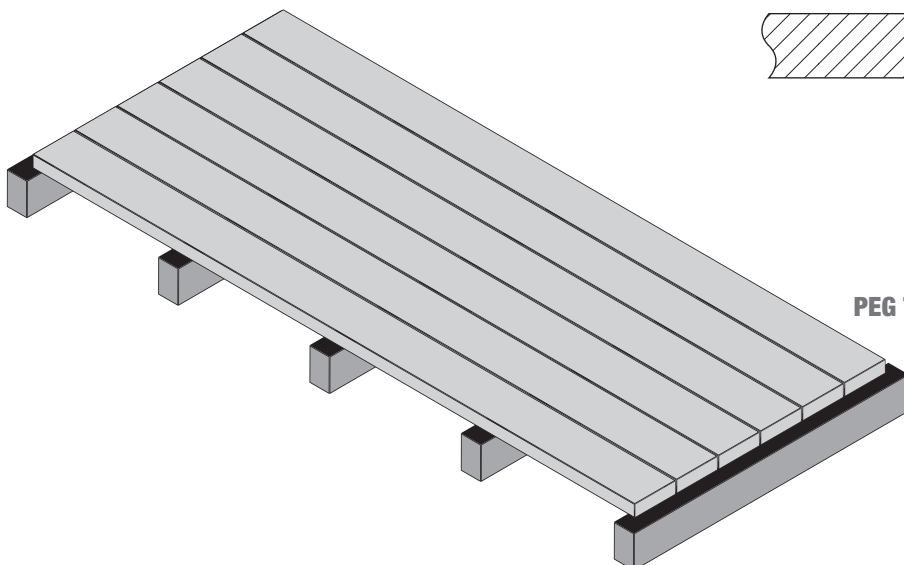

PEG THE FLOOR TO THE GROUND IN A WINDY AREA



20 YEAR WARRANTY

If any component of your shed fails - we will replace it. Make sure your shed is built and secured according to our instructions as a minimum. The warranty does not cover damage or loss through an act of God. Please inform your insurance provider. For a full copy of your warranty, please contact the Mitre 10 store where you purchased your shed.

MANUFACTURED FOR

Mitre 1 0 (New Zealand) Limited
67 Corinthian Drive, Albany, Auckland
New Zealand
Made from imported materials.