

OWNER'S MANUAL



Bestway

CONTENTS

IMPORTANT SAFETY INSTRUCTIONS	pg 003
PRE-SETUP CHECK LIST	pg 007
INSTALLATION	pg 008
SET-UP INSTRUCTION IN WINTER	pg 008
USING THE SPA	pg 011
MAINTENANCE	pg 014
DISASSEMBLY AND STORAGE	pg 016
TROUBLESHOOTING	pg 018
ERROR CODES	pg 019



VISIT BESTWAY YOUTUBE CHANNEL

FOR INSTRUCTION VIDEOS
PLEASE VISIT:

BESTWAYCORP.COM/SUPPORT

IMPORTANT SAFETY INSTRUCTIONS

SAFETY INSTRUCTIONS

WARNING

When installing and using this electrical equipment, basic safety precaution should always be followed, including the following:

IMPORTANT SAFETY INSTRUCTIONS - READ AND FOLLOW ALL INSTRUCTIONS.

WARNING:

- The spa must be supplied through an isolating transformer or supplied through a residual current device (RCD) having a rated residual operating current not exceeding 30mA.
- The pump must be tested before each use, to test follow the instruction of pump.
- If the supply cord is damaged, it must be replaced by the manufacturer, service agent or similarly qualified persons in order to avoid a hazard.
- To reduce the risk of electric shock, do not use extension cord to connect unit to electric supply; provide a properly located outlet.
- No part of the appliance is to be located above the bath during use.
- Parts containing live parts, except parts supplied with safety extra-low voltage not exceeding 12V, must be inaccessible to a person in spa pool; Parts incorporating electrical components, except remote control devices, must be located or fixed so that they cannot fall into the spa pool.
- The plug of pump shall be more than 3.5m away from the spa.
- It is necessary to have the plug accessible after installation of the spa.
- **TO AVOID ELECTRIC SHOCK, DO NOT USE THE SPA WHEN IT IS RAINING.**
- Never wear your contact lenses when in your spa.
- Do not use spa during chemical maintenance.
- The power source on the wall of building should keep more than 4m away from pool and at a height of 1.2m at least.
- Extension cords can't be used.
- Don't plug or unplug the appliance if hand is wet.
- Always unplug the appliance:
 - on rainy days
 - before cleaning or other maintenance
 - if leave it unattended on holidays

WARNING: Always keep plug dry, plug in with wet plug is definitely forbidden!

- The plug shall be directly connected only to an earthed socket-outlet of the fixed electrical installation.
- When the appliance will be not used for a long time, such as in the winter, the spa or pool set should be disassembled and stored indoor.
- Do not let children play when the pool is empty to prevent falls and injuries. Need to arrange the spa or pool to collect in time.
- **Caution** - Read the instruction before using the appliance and installation or reassemble every time
- Safekeeping the instruction. If instruction is missed, please contact with manufacturer or search it in website www.bestwaycorp.com
- **Warning: For electric safety, a leakage current detecting device is incorporated in the power cord, if the leakage current is detected more than 10mA, the device will operate and cut-off the power supply, in such case, please unplug and stop using the spa at once. Don't reset the product by yourself. And you must contact the local service agent to check and repair the product.**
- The appliance must be supplied by earthed power source.
- **WARNING** - This appliance is not intended for use by persons (including children) with reduced physical, sensory or mental capabilities, or lack of experience and

knowledge, unless they have been given supervision or instruction concerning use of the appliance by a person responsible for their safety. Children should be supervised to ensure that they do not play with the appliance.

- Cleaning and user maintenance must be performed by an adult above 18 years old who is familiar with the risk of electric shock;
- Water attracts children; always attach a spa cover after each use.
- Do not bury cord. Locate cord to minimize abuse from lawn mowers, hedge trimmers, and other equipment.
- Risk of Accidental Drowning. Extreme caution must be exercised to prevent unauthorized access by children. To avoid accidents, ensure that children can not use this spa unless they are supervised at all times.
- **RISK OF INJURY.** Never operate spa if inlet / outlet pipes are broken or missing. Never attempt to replace the inlet / outlet pipes. Always consult your local Aftersales centre.
- **RISK OF ELECTRIC SHOCK.** Install at least 2m from all metal surfaces.
- **RISK OF ELECTRIC SHOCK.** Never operate any electrical appliance when in your spa or when your body is wet. Never place any electric appliance, such as a light, telephone, radio, or television, within 2m of spa.
- During pregnancy, soaking in hot water may cause damage to the fetus. Limit use to 10 minutes at a time.
- **TO REDUCE THE RISK OF INJURY:**
 - A. The water in a spa should never exceed 40°C (104°F). Water temperature between 38°C (100°F) and 40°C (104°F) is considered safe for a healthy adult. Lower water temperatures are recommended for young children and when spa use exceeds 10 minutes.
 - B. Since excessive water temperatures have a high potential for causing fetal damage during the early months of pregnancy, pregnant or possibly pregnant women should limit spa water temperature to 38°C (100°F).
 - C. Before entering a spa, the user should measure the water temperature with an accurate thermometer since the tolerance of water temperature regulating device varies.
 - D. The use of alcohol, drugs, or medication before or during spa use may lead to unconsciousness with the possibility of drowning.
 - E. Obese persons and persons with a history of heart disease, low or high blood pressure, circulatory system problems, or diabetes should consult a physician before using a spa.
 - F. Persons using medication should consult a physician before using a spa since some medication may induce drowsiness while other medication may affect heart rate, blood pressure, and circulation.
- **TO REDUCE THE RISK OF INJURY:** Never pour water with a temperature higher than 40°C (104°F) into the spa pool directly.
- The use of alcohol, drugs, or medication can greatly increase the risk of fatal hyperthermia. Hyperthermia occurs when the internal temperature of the body reaches a level that is several degrees above the normal body temperature of 37°C (98.6°F). The symptoms of hyperthermia include an increase in the internal temperature of the body, dizziness, lethargy, drowsiness, and fainting. The effects of hyperthermia include failure to perceive heat; failure to recognize the need to exit spa or hot tub; unawareness of impending hazard; fetal damage in pregnant women; physical inability to exit the spa or hot tub; and unconsciousness resulting in the danger of drowning.
- Electric installations should follow national wiring rules, consult a qualified electrician with any questions.

CONSULT YOUR PHYSICIAN FOR RECOMMENDATIONS.

CAUTION:

- We strongly recommend not to unfold and inflate the spa if the ambient temperature is below 15°C(59°F). We suggest inflating the spa indoors, and then continuing set up outdoors. If the outdoor temperature is lower than 6°C(42.8°F), the spa heater must always be on. In this mode, the Freeze Shield™ system can keep the internal temperature between 6°C(42.8°F) and 10°C(50°F) to prevent damage, such as water freezing in the pipes or the circulation system.

Important: If the Freeze Shield™ system isn't working, alarms will pop up on the spa. Be sure to check the status of your spa if the outdoor temperature is below 6°C(42.8°F). In case of a long-term absence from home when there is a risk of temperatures falling below 6°C(42.8°F), we strongly suggest disassembling the spa and storing it following the storage procedure.

- Do not use the spa alone.
- People with infectious diseases should not use a spa.
- Do not use the spa immediately following strenuous exercise.
- Always enter and exit the spa slowly and cautiously. Wet surfaces are slippery.
- To avoid damage to the pump, the spa must never be operated unless the spa is filled with water.
- Immediately leave spa if the user feels uncomfortable or sleepy.
- Never add water to chemicals. Always add chemicals to water to avoid strong fumes or violent reactions that may result in hazardous chemical spray.
- Regarding the information pertaining to cleaning, maintenance of water, and disposal of water, please see section "MAINTENANCE".
- Regarding the information pertaining to the installation, thanks to refer to the below paragraph of the manual.

CAUTION: In order to avoid a hazard due to inadvertent resetting of the thermal cut-out, this appliance must not be supplied through an external switching device, such as a timer, or connected to a circuit that is regularly switched on and off by the utility.

After using your spa for 3-5 years, you should contact your local qualified maintenance technician to ensure the safety and performance of the spa. The main components, such as heating element, air blower motor and non-return valves within the electric unit should be checked and replaced(if necessary) by professional persons.

NOTE:

- Please examine equipment before use. Notify Bestway at the customer service address listed on this manual for any damaged or missing parts at the time of purchase. Verify that the equipment components represent the models that you had intended to purchase.
- This product is not intended for commercial use.

SAVE THESE INSTRUCTIONS

SELECTED LOCATION

WARNING: The selected location has to be able to support of supporting the expected load.

WARNING: An adequate drainage system has to be provided to deal with overflow water for both indoor and outdoor installations.

IMPORTANT: Because of the combined weight of the Lay-Z-Spa, water, and users, it is extremely important that the base where the Lay-Z-Spa is installed is smooth, flat, level and capable of uniformly supporting the weight for the entire time the Lay-Z-Spa is installed (not on the carpet or other similar material). If the Lay-Z-Spa is placed on a surface, which does not meet these requirements, any damage caused by improper support is not covered under the manufacturer's warranty. It is the responsibility of the Lay-Z-Spa owner to assure the integrity of the site at all times.

1. Indoor Installation:

Be aware of special requirements if you install the spa indoors.

- Humidity is a natural side effect with Lay-Z-Spa installation. Determine the effects of airborne moisture on exposed wood, paper, etc. in the proposed location. To minimize these effects it is best to provide plenty of ventilation to the selected area. An architect can help determine if more ventilation is needed.

2. Outdoor Installation:

- During filling, draining or when in use, water may flow out of the spa. Therefore the Lay-Z-Spa should be installed near a floor drain.
- Do not leave the spa's surface exposed to direct sunlight for long periods of time.

PRCD WARNING

WARNING: Before inserting plug into a power outlet, make sure the current rate of the power outlet is suitable for the pump.

WARNING: Using an extension lead or multi plug adaptor with the spa heater can cause the plug to overheat, causing damage to the equipment and surrounding items. The spa is a class I electrical appliance and must be connected directly to a grounded socket. It is recommended to only use a socket which is resistant to humidity and capable of high power loading. Regularly check the plug and socket for signs of damage before using the spa – do not use the spa if the plug or socket is damaged. If you are unsure about the quality of the electrical supply, please consult a qualified electrician before use.

WARNING: The PRCD plug must be tested before each use to avoid risk of electric shock.

WARNING: Do not use the pump if this test fails. For assistance, please visit the support section on our website, www.bestwaycorp.com.

PRE-SETUP CHECK LIST

PARTS CHECKS



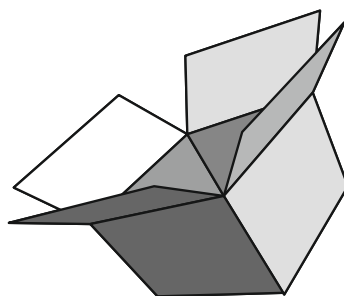





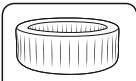
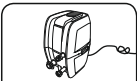
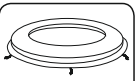
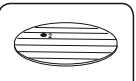
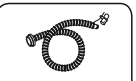

Please examine equipment before use. Notify Bestway® customer service of any damaged or missing parts at the time of purchase. Verify that the equipment components represent the model that you had intended to purchase. For reference please use the diagrams below.

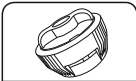
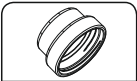

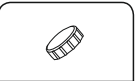
SYDNEY AIRJET S100103 (60137)

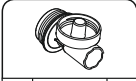
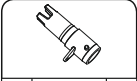
— 1.80 m x 66 cm / 71" x 26"

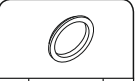

 01 P06369 1	 02 P05331 1	 03 P06370 1	 04 54123GASS17 1	 05 P6931ASS16 1	 06 P05343 1
 07 P05345 1	 08 P05524 2	 09 F4C009B-42ASS17 1	 10 P00217 1	 11 P05320 6	 12 / 2
 13 P61726ASS18 1	 14 P61727ASS18 1	 15 P05346 1	 16 P6609ASS16 1	 17 P05347 1	

INSTALLATION



SET-UP INSTRUCTION IN WINTER

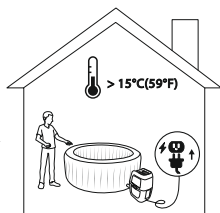
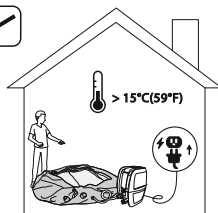
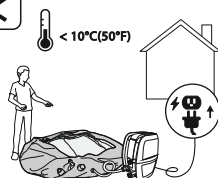

It is important to follow these suggestions if you are setting up the spa during the winter period. This will prevent damage to the PVC material and extend the life of your product drastically.

- If the ambient temperature is below 10°C(50°F), we suggest keeping the package indoor where the temperature is above 15°C(59°F) for at least 2h before inflation. This will make the spa liner more flexible and easier to set up.
- Open the package in the same room where the temperature is above 15°C(59°F), and inflate the spa using the spa heater.
- Position the spa liner outdoor in the desired position, connect the spa heater and fill with water.

Important: The water temperature used to fill the spa must be above 6°C(42.8°F), otherwise when you begin to operate with the spa heater, the E03 alarm will appear.

Important: If the Freeze Shield™ system isn't working, alarms will pop up on the spa. Be sure to check the status of your spa if the outdoor temperature is below 6°C(42.8°F). In case of a long-term absence from home when there is a risk of temperatures falling below 6°C(42.8°F), we strongly suggest disassembling the spa and storing it following the storage procedure. When you assemble the spa, the automatic warm function will turn on. In this condition, the spa can be used when the temperature is lower than 6°C(42.8°F).

1



2



3

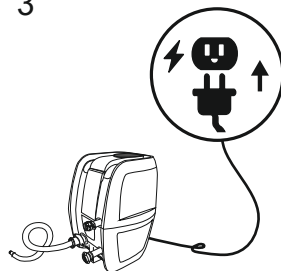

4

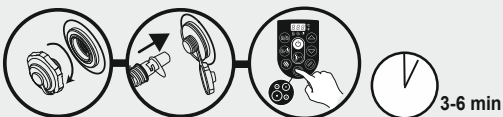
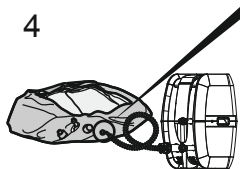

5

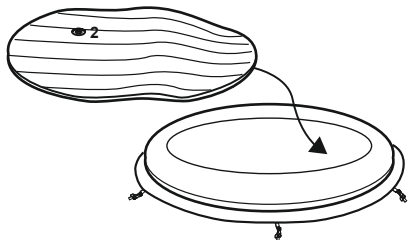

6

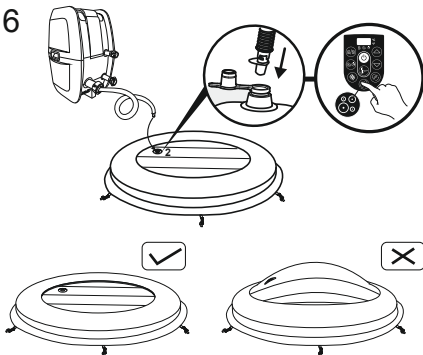

7

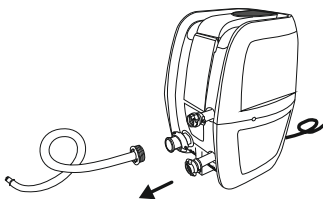

8

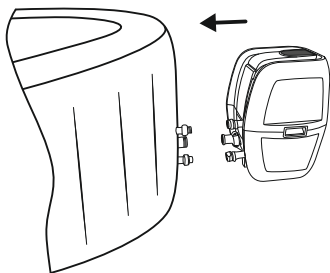

9

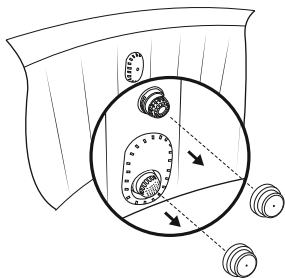

10

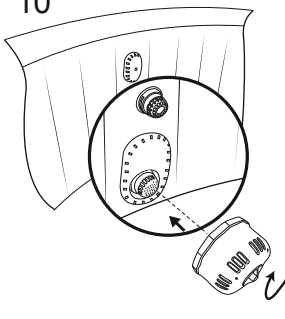

11



PRCD TEST

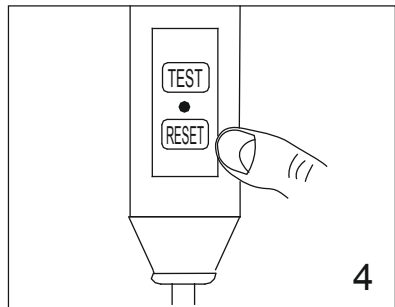
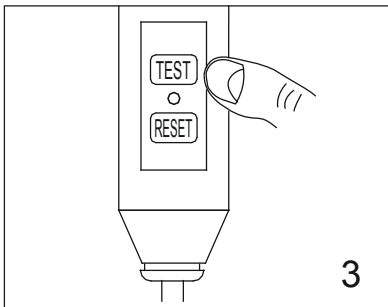
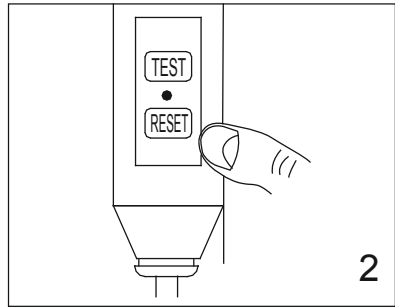
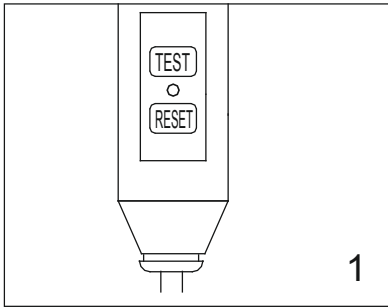

SPA PUMP EQUIPOTENTIAL BONDING TERMINAL

It is recommended to arrange for a qualified electrician to connect the spa pump to an equipotential bonding terminal using a minimum 2.5mm² solid copper conductor.

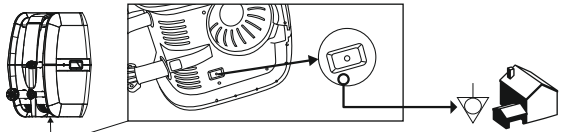

When inflating, you will notice that air will be expelled from the area where the air hose connects to the pump, this is normal for technique requirements.

Important: Don't cover the holes on the base of the inflation hose. This operation will over inflate the liner and damage the structure.

Do not use an air compressor to inflate the pool.

Do not drag the pool on rough ground as this may cause damage to the pool liner.

Inflation time for reference only.

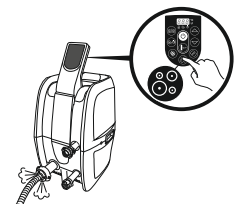

USING THE SPA

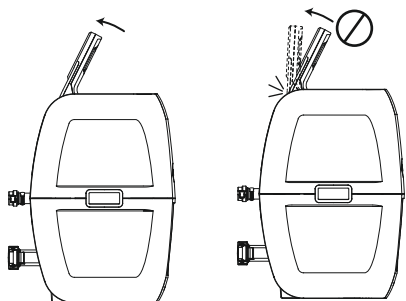





A. LOCK/UNLOCK BUTTON: The pump has a 5-minute auto-lock, this light will turn on. To lock or unlock the pump, place a finger over the lock/unlock button for 3 seconds.











B. POWER-SAVING TIMER BUTTON: Designed to help avoid wasting power by setting the time and duration of the heating cycle for the spa. This way, you can enjoy your spa at the time you desire, without needing to leave the heater on at all times.

STEP 1: Set the heating duration

1. Press the  button until the  LED starts to flash.
2. Press the  or  button to adjust the heating duration (From 1-999 hours).
3. Press the  button again to confirm the heating duration.

STEP 2: Set the number of hours FROM NOW when the heater will activate

1. After setting the heating duration, the  LED starts to flash.
2. Press the  or  button to adjust the hours until time of activation (From 0-999 hours).
3. Press  button again or simply touch nothing for 10 seconds to confirm the setting. The  LED will light steadily, and the countdown to heater activation will begin.

To modify the timer settings: Press the  button and use the  or  button to adjust. Cancel the setting: Press the  button for 2 seconds.

NOTE: After setting, the screen flashes the current temperature and time alternately.

NOTE: Timer adjustment (amount of time with the heater ON) may be set from 1 to 999 hours; Reservation time adjustment (the number of hours FROM NOW when the heater will begin to function) may be set from 0 to 999 hours. If the timer is set at 0 hour, the heating system will activate immediately.

Note that the timer is one time per use - the user sets the duration of the heating cycle, and how many hours from now the heating cycle begins. The timer does NOT repeat until reset.



C. HEAT BUTTON: Use this button to activate the heating system. When the light above the heat button is red, the heating system is activated. When the light is green, the water is at the set temperature and the heating system is at rest.

NOTE: If the heating system is activated the filtration system will automatically start.

NOTE: After turning off the heating system the filtration system will continue to operate.

NOTE: If the spa heater is on when the water temperature is below 6°C(42.8°F), the heating system will warm the water until 10°C(50°F) automatically.



D. MASSAGE SYSTEM BUTTON: Use this button to activate the massage system, which has a 30-minute auto-shutoff feature. The light above the Massage System Button displays red when activated.

IMPORTANT: Do not run the Massage system when the cover is

attached. Air can accumulate inside the spa and cause irreparable damage to the cover and bodily harm.

NOTE: Heat and massage system work together to create a warm massage experience.



E/G. TEMPERATURE ADJUSTMENT BUTTONS: Pressing the Temperature Increase or Decrease buttons will cause the LED to flash. When it is flashing you can adjust to the desired temperature setting. If you hold these buttons down the values will rapidly increase or decrease. The new and desired temperature setting will remain on the LED display for 3 seconds to confirm the new value.



NOTE: The default temperature is 35°C (95°F).

NOTE: Temperature adjustment ranges from 20°C (68°F) to 40°C (104°F).



F. ON/OFF BUTTON: Press this button for 2 seconds to active the control panel buttons and the light turns to green. Press this button for 2 seconds to turn off all currently activated functions.



H. CELSIUS/FAHRENHEIT TOGGLE: The temperature can be displayed in either Fahrenheit or Celsius.



I. WATER FILTER BUTTON: This button turns the filter pump on and off. The light above the Water Filter Button displays red when activated.

POWER-SAVING TIMER LED:



This flashing LED means you are setting the heating duration. The light will be on when the heating function starts to work.



This flashing LED means you are setting the number of hours FROM NOW when the heater will activate. When the light is on, the Power-Saving Timer function is set.

NOTE: The WATER HEATER rate may change in the conditions below:

- When the outdoor temperature is below 15°C (59°F).
- If the cover is not in position when the heating function is activated.

NOTE: To display the current water temperature, run the filter system for at least a minute.

The water temperature as tested by an external thermometer may vary from the temperature as displayed on the spa panel by as much as approximately 2°C(35.6°F).

WINTER USE INSTRUCTIONS



- You can keep the spa on during winter when the temperature is lower than 6°C(42.8°F). The Freeze Shield™ system automatically keeps the water temperature between 6°C(42.8°F) and 10°C(50°F), and it will prevent the water from freezing.

Important: If the water temperature is below 6°C(42.8°F), the spa heater must always

be on. In this mode, the Freeze Shield™ system can keep the internal temperature between 6°C(42.8°F) and 10°C(50°F) to prevent damage, such as water freezing in the pipes or the circulation system.

Important: If the Freeze Shield™ system isn't working, alarms will pop up on the spa. Be sure to check the status of your spa if the outdoor temperature is below 6°C(42.8°F). In case of a long-term absence from home when there is a risk of temperatures falling below 6°C(42.8°F), we strongly suggest disassembling the spa and storing it following the storage procedure.

- Any damage as a result of using the spa in these conditions is the responsibility of the customer. Do not use the spa when the ambient temperature reaches -10°C(14°F).

HEATING RESET

When using the Lay-Z-Spa for first time, or after a long period of inactivity, be sure to press the reset button on the pump using a small and thin object.

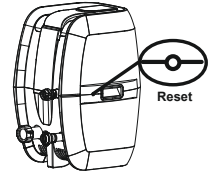

If the temperature on the control panel (or the water temperature) has not changed 4-5 hours after activation of the heating system, use a thin object to press the RESET BUTTON, and restart the heating system.

IMPORTANT: The heating system will not operate if the outside temperature is above 40°C (104 °F) or if the Lay-Z-Spa is under direct sunlight. Under these conditions, please wait until a cooler time of day before pressing the RESET BUTTON with a thin object and restarting the heating system.

IMPORTANT

To reach 40°C (104°F), the heating duration required is based on the starting water temperature and ambient temperature, the data below is purely for reference. To display the current water temperature, run the filter system for at least a minute.

Ambient Temperature	Water Temperature	Set Temperature	Heating Duration
10°C(50°F)	10°C(50°F)	40°C(104°F)	18.5 h
15°C(59°F)	15°C(59°F)	40°C(104°F)	15 h
20°C(68°F)	20°C(68°F)	40°C(104°F)	11.5 h
25°C(77°F)	25°C(77°F)	40°C(104°F)	8.5 h
30°C(86°F)	30°C(86°F)	40°C(104°F)	5.5 h

- Be sure to cover the spa with the spa cover whenever the heating function is activated. Leaving the spa uncovered will increase the heating duration required.
- When the spa is assembled with water, do not switch off the spa heater if the temperature is lower than 6°C(42.8°F).

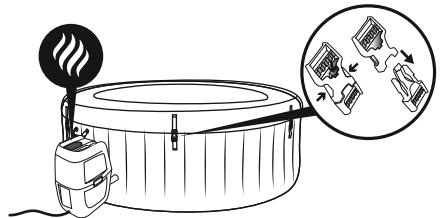

Power Rate	Massage Tube Power	Heat Element Power	Water Pump Power
220-240V AC, 50Hz, Single Phase 2,050W at 20°C	800W	2,000W at 20°C	50W

MAINTENANCE

CAUTION: You must ensure the pump is unplugged before beginning spa maintenance to avoid risk of injury or death.

Adding Air: Your spa will require additional air to be added from time to time. Changes in temperature from day to night will change the pressure in the spa and may cause a certain amount of deflation. Please follow the assembly instructions and inflate to the accurate pressure needed.

When you need to use the pump for inflation, please block the hoses to prevent water from escaping, then disconnect the pump, screw on the cap (P00217) to avoid water coming out from the air pipe.

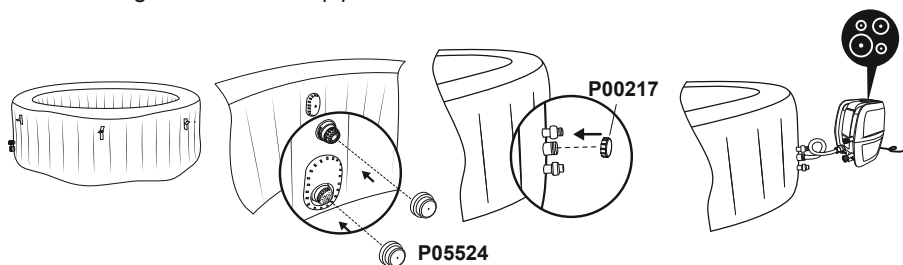

Cover Maintenance

The cover shall be cleaned inside and out periodically using a suitable solution that includes adequate disinfection (e.g. 10 mg/l of Free Chlorine).

Filter Cartridge Maintenance

To ensure your spa water stays clean, check and clean your filter cartridges every day follow the steps below.

NOTE: We recommend changing your filter cartridges every week or, if the filter cartridges remain soiled and discolored, they should be replaced.

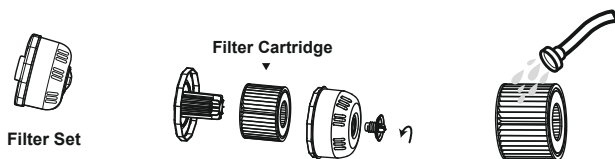

Water Maintenance

Many pollutants in the water settle on surfaces below the water line. These pollutants can cause bacterial, algal or fungal growth. It is recommended that spas are cleaned as regularly as necessary. After a time, tenacious stains or biofilms may develop on the accessible surfaces below the water line or high concentrations of salts or unwanted reaction by-products may also occur. Depending on hygienic condition, cleanliness, visibility, odour, debris and stains, it is recommended to change the water completely and clean/disinfect the spa. When emptying the spa, the regulations and the instructions for draining the water shall be observed.

Keeping your spa water clean and chemically balanced is necessary. Simply cleaning the filter cartridge is not enough for proper maintenance, we recommend you use pool chemicals to maintain water chemistry and chlorine or bromine tablets (do not use granules) with the chemical dispenser.

Water quality will be directly related to frequency of use, number of users and overall maintenance of the spa. The water should be changed every 3 days if there is no chemical treatment being performed with the water. It is highly recommended to use tap water for spa filling to minimize the influence of unwanted content, such as minerals. Barefoot areas and relaxing areas shall be cleaned as well. No cleaning water may flow into the spa or spa water cycle. The dirt and cleaning agents shall be rinsed carefully to drain in the spa surround. **Note:** We recommend you take a shower before using your Lay-Z-Spa, as cosmetic products, lotions, and other residues on the skin can quickly degrade water quality. To use the chemical dispenser, please follow the below instruction.

Using chemical tablets (not included):

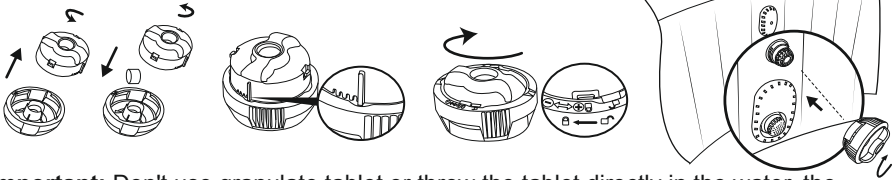

Important: Don't use granulate tablet or throw the tablet directly in the water, the chemical will deposit on the bottom and damage the material and discolored the PVC.

Using chemical liquid (not included):

Important: Add chemical liquid in small doses and in the center of the pool avoid direct contact of the chemical with the spa surface, the direct contact of chemical with spa material will damage the material and discolored the surface.

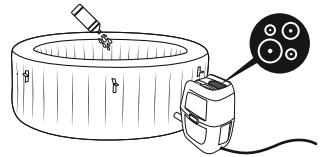

NOTE: Remove the chemical dispenser from spa when the spa is in use. **IMPORTANT:** After performing chemical maintenance and before using the spa, use a test kit (not included) to test the water chemistry. We recommend maintaining your water as below table.

pH	Total Alkalinity	Free Chlorine
7.4-7.6	80-120ppm	2-4ppm

NOTE: Damage resulting from chemical imbalance is not covered by the warranty. Pool chemicals are potentially toxic and should be handled with care. There are serious health risks from chemical vapors and the incorrect labeling and storage of chemical containers. Please consult your local pool supply retailer for more information about chemical maintenance. Pay close attention to the chemical manufacturer's instructions. spa damage resulting from misuse of chemicals and mismanagement of spa water is not covered by the warranty.

Important: Over usage of chemical will discolored the printing and all points of the spa material, in worse case damage the structure of the spa liner.

DISASSEMBLY AND STORAGE

DRAINING THE SPA

1.

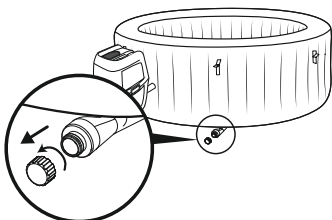

2.

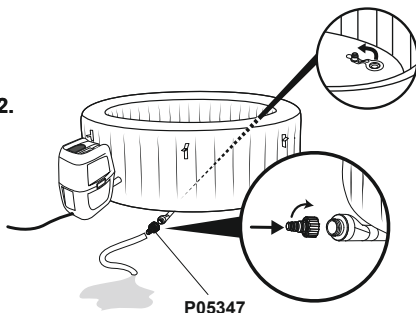

3. **NOTE:** Dry the spa pool.



4.

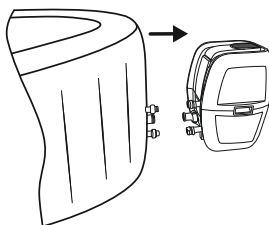

5.

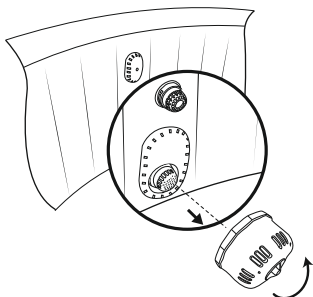

Make sure the spa and pump are completely dry. This is essential to extend the life of the spa. We recommend using the pump to blow dry the spa, pump and pipes. Remove the filter sets and discard the used filter cartridges. Re-attach the two stopper caps onto the spa's inlet and outlet valves. It is recommended you store the spa in its original package in a warm [above 15°C (59°F)] and dry place.

CLEANING THE SPA

Detergent residues and dissolved solids from bathing suits and chemicals may build up on the spa walls. Use soap and water to clean the walls and rinse thoroughly.

NOTE: DO NOT use hard brushes or abrasive cleaners.

DEFLATION

Your spa is equipped with a deflation function to remove all the air from inside the chamber to make it easier to pack and store.

Screw valve 

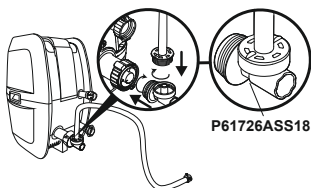

P61727ASS18

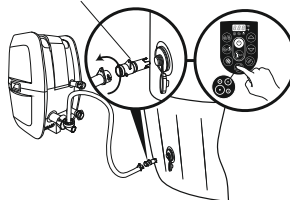

REPAIR

For PVC part.

If the spa is torn or punctured, use the provided underwater adhesive repair patch.

1. Clean area to be repaired.
2. Carefully peel patch.
3. Press patch over area to be repaired.
4. Wait 30 seconds before inflation.



For Tritech PVC material.

If the spa is torn or punctured, use the provided PVC repair patch and glue (not included) following these steps:









1. Clean and dry area to be repaired.
2. Cut the provided PVC patch to appropriate size.
3. Use glue (not included) to coat the one side of the newly cut patch. Make sure the glue is evenly distributed.
4. Wait for 30 seconds and then place the cut patch with glue over the damaged area.
5. Smooth out any bubbles of air that may be trapped underneath, and press firmly for two minutes.
6. The product is once again ready for use. Repeat this process should further leaks occur.
7. Wait 30 minutes before inflation.

TROUBLESHOOTING

Bestway strives to provide the most trouble-free spas on the market. If you experience any problems whatsoever, do not hesitate to contact Bestway or your authorized dealer. Here are some helpful tips to help you to diagnose and rectify some common sources of trouble.

Problems	Probable Causes	Solutions
Pump does not operate	<ul style="list-style-type: none"> - Power failure - Power circuits broken 	<ul style="list-style-type: none"> - Check power source - For assistance, please visit the support section on our website, www.bestwaycorp.com
Pump does not heat properly	<ul style="list-style-type: none"> - Temperature set too low - Dirty Filter Cartridge - The thermal cut-out cut off - spa is not covered - Heating element failed 	<ul style="list-style-type: none"> - Set to a higher temperature refer to section pump operation - Clean/replace the filter cartridge refer to section filter cartridge cleaning and replacement - Unplug the pump, and put the plug in a dry, cool place. Only restart the pump when the water temperature reaches 35°C (95°F) or lower - Attach the cover - For assistance, please visit the support section on our website, www.bestwaycorp.com
Lay-Z-Massage System does not work	<ul style="list-style-type: none"> - Air Pump is overheating - The Lay-Z-SPA Massage stops automatically - Air pump is broken 	<ul style="list-style-type: none"> - Unplug the pump and wait two hours until the pump has cooled. Insert the plug and press the Lay-Z-Massage System Button - Press the Lay-Z-Massage System Button to reactivate - For assistance, please visit the support section on our website, www.bestwaycorp.com
Pump adapters are not level with the spa adapters	One characteristic of PVC is that it changes shape, which is normal	<ul style="list-style-type: none"> - Elevate the pump with wood or another type of insulated material to bring the pump's adapters level with the spa's adapters
spa pool leakage	<ul style="list-style-type: none"> - spa is torn or punctured - Air valve is loose 	<ul style="list-style-type: none"> - Use provided repair patch - Using soapy water, cover the air-valve to check if air is leaking, if so, use the provided wrench to fasten the air-valve following these steps: <ol style="list-style-type: none"> 1. Deflate the spa. 2. With one hand, hold the backside of the air valve from the inner side of the spa wall and turn the wrench clockwise.
Water is not clean	<ul style="list-style-type: none"> - Insufficient filtering time - Dirty Filter Cartridge - Improper water maintenance 	<ul style="list-style-type: none"> - Increase filtration time - Clean/replace the Filter Cartridge (refer to Filter Cartridge Cleaning and Replacement section) - Refer to the chemical manufacturer's instructions
PRCD test failed	Something wrong with the spa	<ul style="list-style-type: none"> - For assistance, please visit the support section on our website, www.bestwaycorp.com
Control panel is not working	<p>The control panel has an auto-lock, which is activated after 5 minutes of inactivity. The LED display has one icon: . If the lock icon is highlighted, the control panel is locked.</p> <ul style="list-style-type: none"> - Control panel is not activated. 	<ul style="list-style-type: none"> - To unlock the control panel, press the  button for 3 seconds. - If the control panel will not unlock, restart the pump – unplug and plug in the pump - Press the on/off button for 2 seconds. If the problem persists. - For assistance, please visit the support section on our website, www.bestwaycorp.com
What kind of chemicals should be used for water maintenance?	Please consult your local chemical supplier for information about chemical maintenance. Pay close attention to the chemical manufacturer's instructions	
Water leaks from the adapters between the pump and spa	<ul style="list-style-type: none"> - Seals are missing inside the pump adapters - Seals are not in the correct position - Seals are damaged - Adapters are not tightened correctly 	<ul style="list-style-type: none"> - Insert the stopper caps on the spa ports to prevent the water from escaping and disconnect the pump. Check if the seals are in place. - If the seals are not in the correct position, open the gears, and place the seals in correct position. - If the seals are damaged, they must be replaced. For assistance, please visit the support section on our website, www.bestwaycorp.com. - If the seals are in correct position, the adapters are not tightened correctly. Connect the pump to the spa, hand-tighten the adapters, and remove the stopper caps from the spa ports. If there is leakage, tighten the adapter until there is no leakage.

ERROR CODES

CAUSES	REASONS	SOLUTIONS
<p>The water flow sensors work without pressing the filter or heat button.</p> 	<ol style="list-style-type: none"> The water flow sensor flags didn't fall back into the correct position. The water flow sensors are broken. 	<ol style="list-style-type: none"> Unplug the plug gently, strike the side of the pump but not violently, and plug it back in. For assistance, please visit the support section on our website, www.bestwaycorp.com.
<p>After starting or during the functions of filtering or/and heating, the water flow sensors do not detect water flow.</p> 	<ol style="list-style-type: none"> You forgot to remove the 2 stopper caps from inside the pool. Filter cartridges are dirty. Activate the filter or heat system and put your hand in front of the outlet pipe inside the pool to check if you can feel water flowing out. <ol style="list-style-type: none"> If no water flows out the water pump is broken. Water flows out but the alarm  appears, the water flow sensors are broken. Filter blockage Bent pipes or poor water flow through the plastic pipes of the liner Debris screens are blocked: debris screens can become blocked by hard water due to calcium build-up. Perished washers The washers within the spa couplings may have become perished or worn. 	<ol style="list-style-type: none"> Remove the 2 stopper caps before heating, refer to Assembly section in the User's Manual. Remove the filter set from inside the pool and push the filter or heat button. If no alarm appears, clean or change the filter cartridges install the filter set inside the pool. For assistance, please visit the support section on our website, www.bestwaycorp.com. Clean the filter and check for damage. Replace or re-install as necessary. For assistance, please visit the support section on our website, www.bestwaycorp.com. Please check through the spa connection to see if the pipes are bending. For assistance, please visit the support section on our website, www.bestwaycorp.com. Empty the spa and place a garden hose inside the pipes to wash the debris. To be sure all debris are removed, perform the operation from the outside and inside of the spa. Use a toothbrush to remove any stubborn debris. For assistance, please visit the support section on our website, www.bestwaycorp.com. Check the washers inside the coupling for damage. Unscrew the couplings and remove the washer for further inspection. For assistance, please visit the support section on our website, www.bestwaycorp.com.
<p>The pump's thermometer reads the water temperature below 4°C (40°F).</p> 	<ol style="list-style-type: none"> The water temperature is lower than 4°C (40°F) If the water temperature is higher than 7°C (44.6°F), the pump's thermometer is broken. 	<ol style="list-style-type: none"> The spa is not designed to operate with water temperatures lower than 4°C (40°F). Unplug the pump and only re-start the pump when the water temperature reaches 6°C (43°F). For assistance, please visit the support section on our website, www.bestwaycorp.com.
<p>The pump's thermometer reads the water temperature over 50°C (122°F).</p> 	<ol style="list-style-type: none"> The water temperature is over 50°C (122°F) The ambient temperature is higher than 40°C (104°F) or the spa is exposed to direct sunlight for an extended period of time. If the water temperature is lower than 45°C (113°F), the pump's thermometer is broken. 	<ol style="list-style-type: none"> The spa is not designed to operate with water temperatures greater than 40°C (104°F). Unplug the pump and only re-start the pump when the water temperature reaches 38°C (100°F) or lower. IMPORTANT: Before you re-start the pump, push the pump's reset button. Disconnect the plug, detach the pump and drain the spa. After 15 minutes, reattach the pump, reconnect the plug and restart the heating function. If the alarm appears again, consider moving the spa to another location without direct sunlight. For assistance, please visit the support section on our website, www.bestwaycorp.com.
<p>The pump's thermometer connections have issues.</p> 	<ol style="list-style-type: none"> The pump's thermometer connectors don't work properly. The pump's thermometer is broken. 	<p>For assistance, please visit the support section on our website, www.bestwaycorp.com.</p>
<p>The manual reset thermal cut-out has problem</p> 	<p>The manual reset thermal cut-out trips off.</p>	<ol style="list-style-type: none"> Unplug the pump and push the reset button, then plug the pump back in. In case the alarm still remains, check the RESET BUTTON section in manual. For assistance, please visit the support section on our website, www.bestwaycorp.com.
<p>Ground Connection Failed.</p> 	<ol style="list-style-type: none"> The ground bonding of your home has some problem. The pump has some problem. 	<p>For assistance, please visit the support section on our website, www.bestwaycorp.com.</p>



For support please visit us at:
bestwaycorp.com/support

©2020 Bestway Inflatables & Material Corp.

All rights reserved/Tous droits réservés/Todos los derechos reservados/Alle Rechte vorbehalten/Tutti i diritti riservati

®™ Trademarks used in some countries under license to/

Marques ®™ utilisées dans certains pays sous la licence de/

Marcas comerciales ®™ utilizadas en algunos países bajo la licencia de/

®™ Die Warenzeichen werden in einigen Ländern verwendet unter Lizenz der/

®™ Marchi utilizzati in alcuni paesi concessi in licenza a

Bestway Inflatables & Material Corp., No.3065 Cao An Road, Shanghai, 201812, China.

Manufactured, distributed and represented in the European Union by/

Fabriqué, distribués et représentés dans l'Union Européenne par/Fabricado, distribuido y representado en la Unión Europea por/

Hergestellt, vertrieben und in der Europäischen Union vertreten von/Prodotto, distribuito e rappresentato nell'Unione Europea da

Bestway (Europe) S.r.l., Via Resistenza, 5, 20098 San Giuliano Milanese (Milano), Italy

Distributed in North America by/Distribués en Amérique du Nord par/Distribuido en Norteamérica por

Bestway (USA) Inc., 3411 E. Harbour Drive, Phoenix, Arizona 85034, United States of America

Tel: +86 21 69135588 (For U.S. and Canada)

Distributed in Latin America by/Distribués en Amérique latine par/Distribuido en Latinoamérica por/Distribuido en América Latina por

Bestway Central & South America Ltda, Salar Ascotan 1282, Parque Enea, Pudahuel, Santiago, Chile

Distributed in Australia & New Zealand by **Bestway Australia Pty Ltd, Unit 2/98-104 Carnarvon St Silverwater, NSW 2128, Australia**

Tel: Australia: (+61) 29 0371 388; New Zealand: 0800 142 101

Exported by/Exporté par/Exportado por/Exportiert von/Esportato da

Bestway (Hong Kong) International Ltd./Bestway Enterprise Company Limited

Suite 713, 7/Floor, East Wing, Tsim Sha Tsui Centre, 66 Mody Road, Kowloon, Hong Kong

www.bestwaycorp.com